

# Technical Information

## Proline Promass S 300

Coriolis flowmeter



Easy-to-clean, self-drainable single-tube system with a compact, easily accessible transmitter

### Application

- Measuring principle operates independently of physical fluid properties such as viscosity or density
- Dedicated to applications requiring optimal cleanability under hygienic conditions

### Device properties

- Large range of hygienic process connections
- 3-A and EHEDG conform
- Fast recovery from CIP/SIP
- Compact hygienic dual-compartment housing with IP69 and up to 3 I/Os
- Backlit display with touch control and WLAN access
- Remote display available

### Your benefits

- Increased process safety – easy cleanable and fully self-drainable tube design
- Fewer process measuring points – multivariable measurement (flow, density, temperature)
- Space-saving installation – no inlet/outlet run needs
- Full access to process and diagnostic information – numerous, freely combinable I/Os and fieldbuses
- Reduced complexity and variety – freely configurable I/O functionality
- Integrated verification – Heartbeat Technology

## Table of contents





<b>About this document</b> . . . . .	<b>4</b>	Climate class . . . . .	52
Symbols . . . . .	4	Degree of protection . . . . .	52
<b>Function and system design</b> . . . . .	<b>5</b>	Vibration- and shock-resistance . . . . .	52
Measuring principle . . . . .	5	Interior cleaning . . . . .	53
Measuring system . . . . .	6	Electromagnetic compatibility (EMC) . . . . .	53
Equipment architecture . . . . .	7	<b>Process</b> . . . . .	<b>53</b>
Safety . . . . .	7	Medium temperature range . . . . .	53
<b>Input</b> . . . . .	<b>10</b>	Density . . . . .	54
Measured variable . . . . .	10	Pressure-temperature ratings . . . . .	54
Measuring range . . . . .	10	Sensor housing . . . . .	57
Operable flow range . . . . .	10	Flow limit . . . . .	58
Input signal . . . . .	10	Pressure loss . . . . .	58
<b>Output</b> . . . . .	<b>12</b>	System pressure . . . . .	58
Output and input variants . . . . .	12	Thermal insulation . . . . .	58
Output signal . . . . .	14	Heating . . . . .	59
Signal on alarm . . . . .	19	Vibrations . . . . .	59
Ex connection data . . . . .	22	<b>Mechanical construction</b> . . . . .	<b>60</b>
Low flow cut off . . . . .	23	Dimensions in SI units . . . . .	60
Galvanic isolation . . . . .	23	Dimensions in US units . . . . .	70
Protocol-specific data . . . . .	24	Weight . . . . .	76
<b>Power supply</b> . . . . .	<b>29</b>	Materials . . . . .	77
Terminal assignment . . . . .	29	Process connections . . . . .	79
Device plugs available . . . . .	29	Surface roughness . . . . .	79
Supply voltage . . . . .	31	<b>Human interface</b> . . . . .	<b>79</b>
Power consumption . . . . .	31	Operating concept . . . . .	79
Current consumption . . . . .	31	Languages . . . . .	79
Power supply failure . . . . .	31	Local operation . . . . .	80
Electrical connection . . . . .	31	Remote operation . . . . .	81
Potential equalization . . . . .	41	Service interface . . . . .	86
Terminals . . . . .	41	Network integration . . . . .	87
Cable entries . . . . .	41	Supported operating tools . . . . .	88
Pin assignment, device plug . . . . .	41	HistoROM data management . . . . .	89
Cable specification . . . . .	42	<b>Certificates and approvals</b> . . . . .	<b>91</b>
<b>Performance characteristics</b> . . . . .	<b>45</b>	CE mark . . . . .	91
Reference operating conditions . . . . .	45	RCM-tick symbol . . . . .	91
Maximum measured error . . . . .	45	Ex approval . . . . .	91
Repeatability . . . . .	47	Sanitary compatibility . . . . .	92
Response time . . . . .	47	Pharmaceutical compatibility . . . . .	92
Influence of ambient temperature . . . . .	47	Functional safety . . . . .	92
Influence of medium temperature . . . . .	47	HART certification . . . . .	93
Influence of medium pressure . . . . .	48	FOUNDATION Fieldbus certification . . . . .	93
Design fundamentals . . . . .	48	Certification PROFIBUS . . . . .	93
<b>Installation</b> . . . . .	<b>49</b>	EtherNet/IP certification . . . . .	93
Mounting location . . . . .	49	Certification PROFINET . . . . .	93
Orientation . . . . .	50	Pressure Equipment Directive . . . . .	93
Inlet and outlet runs . . . . .	51	Radio approval . . . . .	94
Special mounting instructions . . . . .	51	Additional certification . . . . .	94
<b>Environment</b> . . . . .	<b>52</b>	Other standards and guidelines . . . . .	94
Ambient temperature range . . . . .	52	<b>Ordering information</b> . . . . .	<b>94</b>
Storage temperature . . . . .	52	<b>Application packages</b> . . . . .	<b>95</b>
		Diagnostics functions . . . . .	95

Heartbeat Technology . . . . .	95
Concentration . . . . .	96
Special density . . . . .	96
OPC-UA server . . . . .	96
<b>Accessories . . . . .</b>	<b>96</b>
Device-specific accessories . . . . .	96
Communication-specific accessories . . . . .	97
Service-specific accessories . . . . .	98
System components . . . . .	99
<b>Supplementary documentation . . . . .</b>	<b>99</b>
Standard documentation . . . . .	99
Device-dependent additional documentation . . . . .	100
<b>Registered trademarks . . . . .</b>	<b>101</b>





## About this document

### Symbols









#### Electrical symbols

Symbol	Meaning
	Direct current
	Alternating current
	Direct current and alternating current
	<b>Ground connection</b> A grounded terminal which, as far as the operator is concerned, is grounded via a grounding system.
	<b>Protective Earth (PE)</b> A terminal which must be connected to ground prior to establishing any other connections.  The ground terminals are situated inside and outside the device: <ul style="list-style-type: none"> <li>▪ Inner ground terminal: Connects the protective earth to the mains supply.</li> <li>▪ Outer ground terminal: Connects the device to the plant grounding system.</li> </ul>

#### Communication symbols



Symbol	Meaning
	<b>Wireless Local Area Network (WLAN)</b> Communication via a wireless, local network.
	<b>LED</b> Light emitting diode is off.
	<b>LED</b> Light emitting diode is on.
	<b>LED</b> Light emitting diode is flashing.

#### Symbols for certain types of information

Symbol	Meaning
	<b>Permitted</b> Procedures, processes or actions that are permitted.
	<b>Preferred</b> Procedures, processes or actions that are preferred.
	<b>Forbidden</b> Procedures, processes or actions that are forbidden.
	<b>Tip</b> Indicates additional information.
	Reference to documentation.
	Reference to page.
	Reference to graphic.
	Visual inspection.



Symbols in graphics

Symbol	Meaning
1, 2, 3, ...	Item numbers
1, 2, 3, ...	Series of steps
A, B, C, ...	Views
A-A, B-B, C-C, ...	Sections
	Hazardous area
	Safe area (non-hazardous area)
	Flow direction

Function and system design

Measuring principle

The measuring principle is based on the controlled generation of Coriolis forces. These forces are always present in a system when both translational and rotational movements are superimposed.

$$F_c = 2 \cdot \Delta m (v \cdot \omega)$$

$F_c$  = Coriolis force

$\Delta m$  = moving mass

$\omega$  = rotational velocity

$v$  = radial velocity in rotating or oscillating system

The amplitude of the Coriolis force depends on the moving mass  $\Delta m$ , its velocity  $v$  in the system and thus on the mass flow. Instead of a constant rotational velocity  $\omega$ , the sensor uses oscillation.

In the sensor, an oscillation is produced in the measuring tube. The Coriolis forces produced at the measuring tube cause a phase shift in the tube oscillations (see illustration):

- If there is zero flow (i.e. when the fluid stands still), the oscillation measured at points A and B has the same phase (no phase difference) (1).
- Mass flow causes deceleration of the oscillation at the inlet of the tubes (2) and acceleration at the outlet (3).

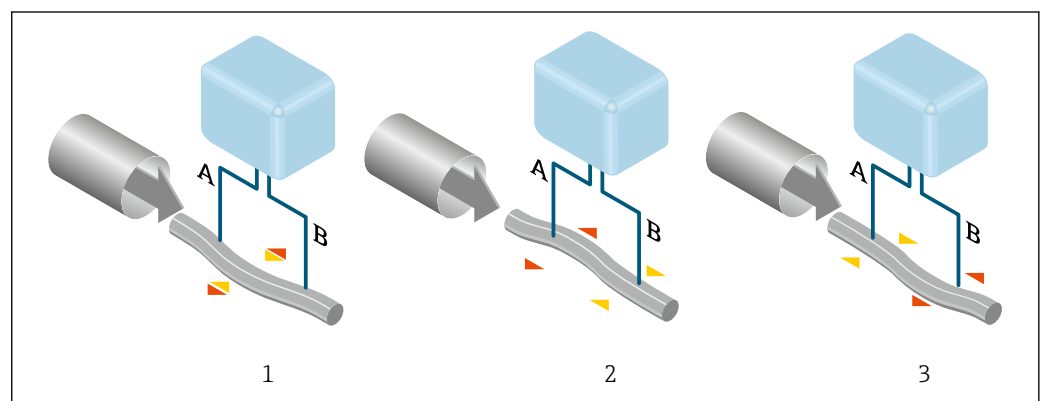

A0029932

The phase difference (A-B) increases with increasing mass flow. Electrodynamical sensors register the tube oscillations at the inlet and outlet. System balance is created by exciting an eccentrically arranged swinging mass to antiphase oscillation. The measuring principle operates independently of temperature, pressure, viscosity, conductivity and flow profile.

**Density measurement**

The measuring tube is continuously excited at its resonance frequency. A change in the mass and thus the density of the oscillating system (comprising measuring tube and fluid) results in a corresponding, automatic adjustment in the oscillation frequency. Resonance frequency is thus a function of medium density. The microprocessor utilizes this relationship to obtain a density signal.

**Volume measurement**

Together with the measured mass flow, this is used to calculate the volume flow.

**Temperature measurement**

The temperature of the measuring tube is determined in order to calculate the compensation factor due to temperature effects. This signal corresponds to the process temperature and is also available as an output signal.

**Measuring system**

The device consists of a transmitter and a sensor.

The device is available as a compact version:

The transmitter and sensor form a mechanical unit.

**Transmitter**

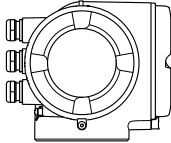
<p><b>Promass 300</b></p>  <p>A0026708</p>	<p>Device versions and materials:</p> <ul style="list-style-type: none"> <li>▪ Transmitter housing <ul style="list-style-type: none"> <li>▪ Aluminum, coated: aluminum, AlSi10Mg, coated</li> <li>▪ Stainless, hygienic: stainless steel, 1.4404</li> </ul> </li> <li>▪ Material of window in transmitter housing: <ul style="list-style-type: none"> <li>▪ Aluminum, coated: glass</li> <li>▪ Stainless, hygienic: polycarbonate</li> </ul> </li> </ul> <p>Configuration:</p> <ul style="list-style-type: none"> <li>▪ External operation via 4-line, backlit, graphic local display with touch control and guided menus ("Make-it-run" wizards) for application-specific commissioning.</li> <li>▪ Via service interface or WLAN interface: <ul style="list-style-type: none"> <li>▪ Operating tools (e.g. FieldCare, DeviceCare)</li> <li>▪ Web server (access via Web browser, e.g. Microsoft Internet Explorer, Microsoft Edge)</li> </ul> </li> </ul>
---	---

**Sensor**

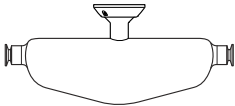
<p><b>Promass S</b></p>  <p>A0026710</p>	<ul style="list-style-type: none"> <li>▪ Bent single-tube system</li> <li>▪ Hygienic design and sensitive fluid handling</li> <li>▪ Simultaneous measurement of flow, volume flow, density and temperature (multivariable)</li> <li>▪ Immune to process influences</li> <li>▪ Nominal diameter range: DN 8 to 50 (3/8 to 2")</li> <li>▪ Materials: <ul style="list-style-type: none"> <li>▪ Sensor: stainless steel, 1.4301 (304)</li> <li>▪ Measuring tubes: stainless steel, 1.4435 (316L)</li> <li>▪ Process connections: stainless steel, 1.4435 (316L), stainless steel, 1.4404 (316/316L)</li> <li>▪ Surface quality: Ra<sub>max</sub> 0.8 µm (32 µin)</li> </ul> </li> </ul>
---	---

Equipment architecture

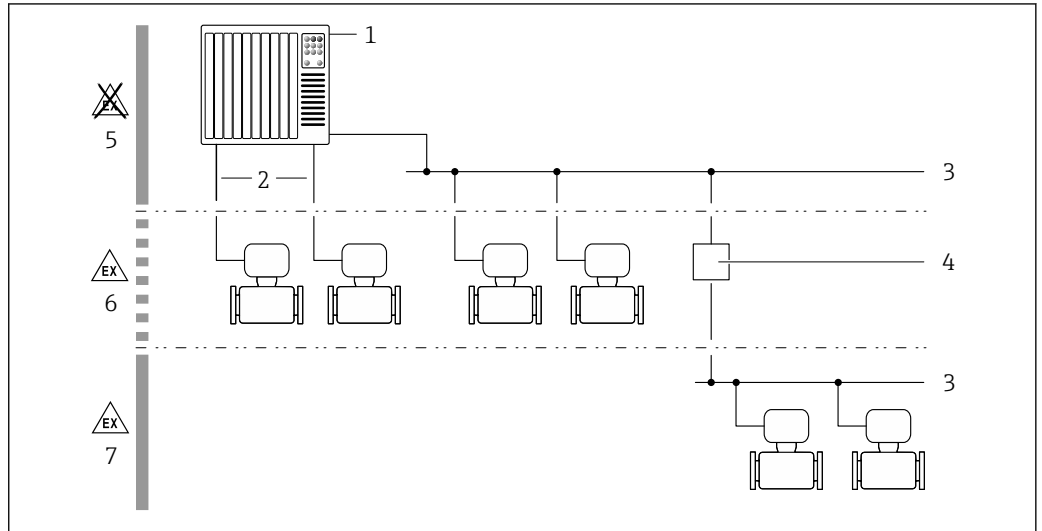

A0027512

1 Possibilities for integrating measuring devices into a system

- 1 Control system (e.g. PLC)
- 2 Connecting cable (0/4 to 20 mA HART etc.)
- 3 Fieldbus
- 4 Coupler
- 5 Non-hazardous area
- 6 Hazardous area: Zone 2; Class I, Division 2
- 7 Hazardous area: Zone 1; Class I, Division 1

Safety

IT security

Our warranty is valid only if the device is installed and used as described in the Operating Instructions. The device is equipped with security mechanisms to protect it against any inadvertent changes to the settings.

IT security measures, which provide additional protection for the device and associated data transfer, must be implemented by the operators themselves in line with their security standards.

Device-specific IT security

The device offers a range of specific functions to support protective measures on the operator's side. These functions can be configured by the user and guarantee greater in-operation safety if used correctly. An overview of the most important functions is provided in the following section.

Function/interface	Factory setting	Recommendation
Write protection via hardware write protection switch → 8	Not enabled.	On an individual basis following risk assessment.
Access code (also applies for Web server login or FieldCare connection) → 8	Not enabled (0000).	Assign a customized access code during commissioning.
WLAN (order option in display module)	Enabled.	On an individual basis following risk assessment.
WLAN security mode	Enabled (WPA2-PSK)	Do not change.
WLAN passphrase (password) → 8	Serial number	Assign an individual WLAN passphrase during commissioning.
WLAN mode	Access Point	On an individual basis following risk assessment.
Web server → 8	Enabled.	On an individual basis following risk assessment.
CDI-RJ45 service interface → 9	-	On an individual basis following risk assessment.

*Protecting access via hardware write protection*

Write access to the device parameters via the local display, Web browser or operating tool (e.g. FieldCare, DeviceCare) can be disabled via a write protection switch (DIP switch on the motherboard). When hardware write protection is enabled, only read access to the parameters is possible.

Hardware write protection is disabled when the device is delivered.

*Protecting access via a password*

Different passwords are available to protect write access to the device parameters or access to the device via the WLAN interface.

- **User-specific access code**  
Protect write access to the device parameters via the local display, Web browser or operating tool (e.g. FieldCare, DeviceCare). Access authorization is clearly regulated through the use of a user-specific access code.
- **WLAN passphrase**  
The network key protects a connection between an operating unit (e.g. notebook or tablet) and the device via the WLAN interface which can be ordered as an option.
- **Infrastructure mode**  
When the device is operated in infrastructure mode, the WLAN passphrase corresponds to the WLAN passphrase configured on the operator side.

*User-specific access code*

Write access to the device parameters via the local display, Web browser or operating tool (e.g. FieldCare, DeviceCare) can be protected by the modifiable, user-specific access code.

*WLAN passphrase: Operation as WLAN access point*

A connection between an operating unit (e.g. notebook or tablet) and the device via the WLAN interface, which can be ordered as an optional extra, is protected by the network key. The WLAN authentication of the network key complies with the IEEE 802.11 standard.

When the device is delivered, the network key is pre-defined depending on the device. It can be changed via the **WLAN settings** submenu in the **WLAN passphrase** parameter.

*Infrastructure mode*

A connection between the device and WLAN access point is protected by means of an SSID and passphrase on the system side. Please contact the relevant system administrator for access.

*General notes on the use of passwords*

- The access code and network key supplied with the device should be changed during commissioning.
- Follow the general rules for generating a secure password when defining and managing the access code or network key.
- The user is responsible for the management and careful handling of the access code and network key.

*Access via Web server*

The device can be operated and configured via a Web browser with the integrated Web server. The connection is via the service interface (CDI-RJ45) or the WLAN interface. For device versions with the EtherNet/IP and PROFINET communication protocols, the connection can also be established via the terminal connection for signal transmission with EtherNet/IP or PROFINET (RJ45 connector).

The Web server is enabled when the device is delivered. The Web server can be disabled if necessary (e.g. after commissioning) via the **Web server functionality** parameter.

The device and status information can be hidden on the login page. This prevents unauthorized access to the information.



For detailed information on device parameters, see:  
The "Description of Device Parameters" document → 100

*Access via OPC-UA*

The "OPC UA Server" application package is available in the device version with the HART communication protocol → 96.

The device can communicate with OPC UA clients using the "OPC UA Server" application package.

The OPC UA server integrated in the device can be accessed via the WLAN access point using the WLAN interface - which can be ordered as an optional extra - or the service interface (CDI-RJ45) via Ethernet network. Access rights and authorization as per separate configuration.



The following Security Modes are supported as per the OPC UA Specification (IEC 62541):

- None
- Basic128Rsa15 – signed
- Basic128Rsa15 – signed and encrypted

*Access via service interface (CDI-RJ45)*

The device can be connected to a network via the service interface (CDI-RJ45). Device-specific functions guarantee the secure operation of the device in a network.

The use of relevant industrial standards and guidelines that have been defined by national and international safety committees, such as IEC/ISA62443 or the IEEE, is recommended. This includes organizational security measures such as the assignment of access authorization as well as technical measures such as network segmentation.

-  Transmitters with an Ex de approval may not be connected via the service interface (CDI-RJ45)!  
Order code for "Approval transmitter + sensor", options (Ex de): BA, BB, C1, C2, GA, GB, MA, MB, NA, NB
-  The device can be integrated in a ring topology. The device is integrated via the terminal connection for signal transmission (output 1) and the connection to the service interface (CDI-RJ45) .

## Input

### Measured variable

#### Direct measured variables

- Mass flow
- Density
- Temperature

#### Calculated measured variables



- Volume flow
- Corrected volume flow
- Reference density

### Measuring range

#### Measuring range for liquids

DN		Measuring range full scale values $\dot{m}_{\min(F)}$ to $\dot{m}_{\max(F)}$	
[mm]	[in]	[kg/h]	[lb/min]
8	$\frac{3}{8}$	0 to 2 000	0 to 73.50
15	$\frac{1}{2}$	0 to 6 500	0 to 238.9
25	1	0 to 18 000	0 to 661.5
40	$1\frac{1}{2}$	0 to 45 000	0 to 1 654
50	2	0 to 70 000	0 to 2 573

#### Recommended measuring range

 Flow limit →  58

### Operable flow range

Over 1000 : 1.

Flow rates above the preset full scale value do not override the electronics unit, with the result that the totalizer values are registered correctly.

### Input signal

#### Input and output versions

→  12

#### External measured values

To increase the accuracy of certain measured variables, the automation system can continuously write various measured values to the measuring device:

- Operating pressure to increase accuracy (Endress+Hauser recommends the use of a pressure measuring device for absolute pressure, e.g. Cerabar M or Cerabar S)
- Medium temperature to increase accuracy (e.g. iTEMP)

 Various pressure transmitters and temperature measuring devices can be ordered from Endress +Hauser: see "Accessories" section →  99

#### HART protocol

The measured values are written from the automation system to the measuring device via the HART protocol. The pressure transmitter must support the following protocol-specific functions:

- HART protocol
- Burst mode

#### Current input

The measured values are written from the automation system to the measuring device via the current input →  11.

*Digital communication*

The measured values can be written from the automation system to the measuring via:

- FOUNDATION Fieldbus
- PROFIBUS DP
- PROFIBUS PA
- Modbus RS485
- EtherNet/IP
- PROFINET

**Current input 0/4 to 20 mA**

<b>Current input</b>	0/4 to 20 mA (active/passive)
<b>Current span</b>	<ul style="list-style-type: none"> <li>■ 4 to 20 mA (active)</li> <li>■ 0/4 to 20 mA (passive)</li> </ul>
<b>Resolution</b>	1 µA
<b>Voltage drop</b>	Typically: 0.6 to 2 V for 3.6 to 22 mA (passive)
<b>Maximum input voltage</b>	≤ 30 V (passive)
<b>Open-circuit voltage</b>	≤ 28.8 V (active)
<b>Possible input variables</b>	<ul style="list-style-type: none"> <li>■ Pressure</li> <li>■ Temperature</li> <li>■ Density</li> <li>■</li> </ul>

**Status input**

<b>Maximum input values</b>	<ul style="list-style-type: none"> <li>■ DC -3 to 30 V</li> <li>■ If status input is active (ON): <math>R_i &gt; 3 \text{ k}\Omega</math></li> </ul>
<b>Response time</b>	Configurable: 5 to 200 ms
<b>Input signal level</b>	<ul style="list-style-type: none"> <li>■ Low signal: DC -3 to +5 V</li> <li>■ High signal: DC 12 to 30 V</li> </ul>
<b>Assignable functions</b>	<ul style="list-style-type: none"> <li>■ Off</li> <li>■ Reset the individual totalizers separately</li> <li>■ Reset all totalizers</li> <li>■ Flow override</li> </ul>

## Output

### Output and input variants

Depending on the option selected for output/input 1, different options are available for the other outputs and inputs. Only one option can be selected for each output/input 1 to 3. The following tables must be read vertically (↓).

Example: If the option BA "4–20 mA HART" was selected for output/input 1, one of the options A, B, D, E, F, H, I or J is available for output 2 and one of the options A, B, D, E, F, H, I or J is available for output 3.

### Output/input 1 and options for output/input 2

 Options for output/input 3



Order code for "Output; input 1" (020) →	Possible options										
Current output 4 to 20 mA HART	BA										
Current output 4 to 20 mA HART Ex i passive	↓	CA									
Current output 4 to 20 mA HART Ex i active		↓	CC								
FOUNDATION Fieldbus			↓	SA							
FOUNDATION Fieldbus Ex i				↓	TA						
PROFIBUS DP					↓	LA					
PROFIBUS PA						↓	GA				
PROFIBUS PA Ex i							↓	HA			
Modbus RS485								↓	MA		
EtherNet/IP 2-port switch integrated									↓	NA	
PROFINET 2-port switch integrated										↓	RA
<b>Order code for "Output; input 2" (021) →</b>	↓	↓	↓	↓	↓	↓	↓	↓	↓	↓	↓
Not assigned	A	A	A	A	A	A	A	A	A	A	A
Current output 4 to 20 mA	B			B		B	B		B	B	B
Current output 4 to 20 mA Ex i passive		C	C		C			C			
User-configurable input/output <sup>1)</sup>	D			D		D	D		D	D	D
Pulse/frequency/switch output	E			E		E	E		E	E	E
Double pulse output <sup>2)</sup>	F								F		
Pulse/frequency/switch output Ex i passive		G	G		G			G			
Relay output	H			H		H	H		H	H	H
Current input 0/4 to 20 mA	I			I		I	I		I	I	I
Status input	J			J		J	J		J	J	J

1) A specific input or output can be assigned to a user-configurable input/output →  19.

2) If double pulse output (F) is selected for output/input 2 (021), only the double pulse output (F) option is available for selection for output/input 3 (022).



**Output/input 1 and options for output/input 3**

 Options for output/input 2 →  12

Order code for "Output; input 1" (020) →	Possible options										
Current output 4 to 20 mA HART	BA										
Current output 4 to 20 mA HART Ex i passive	↓	CA									
Current output 4 to 20 mA HART Ex i active		↓	CC								
FOUNDATION Fieldbus			↓	SA							
FOUNDATION Fieldbus Ex i				↓	TA						
PROFIBUS DP					↓	LA					
PROFIBUS PA						↓	GA				
PROFIBUS PA Ex i							↓	HA			
Modbus RS485								↓	MA		
EtherNet/IP 2-port switch integrated									↓	NA	
PROFINET 2-port switch integrated										↓	RA
<b>Order code for "Output; input 3" (022) →</b>	↓	↓	↓	↓	↓	↓	↓	↓	↓	↓	↓
Not assigned	A	A	A	A	A	A	A	A	A	A	A
Current output 4 to 20 mA	B					B			B	B	B
Current output 4 to 20 mA Ex i passive		C	C								
User-configurable input/output	D					D			D	D	D
Pulse/frequency/switch output	E					E			E	E	E
Double pulse output (slave) <sup>1)</sup>	F								F		
Pulse/frequency/switch output Ex i passive		G	G								
Relay output	H					H			H	H	H
Current input 0/4 to 20 mA	I					I			I	I	I
Status input	J					J			J	J	J

1) If double pulse output (F) is selected for output/input 2 (021), only the double pulse output (F) option is available for output/input 3 (022).

## Output signal

## Current output 4 to 20 mA HART

Order code	"Output; Input 1" (20): Option BA: current output 4 to 20 mA HART
Signal mode	Can be set to: <ul style="list-style-type: none"> <li>■ Active</li> <li>■ Passive</li> </ul>
Current range	Can be set to: <ul style="list-style-type: none"> <li>■ 4 to 20 mA NAMUR</li> <li>■ 4 to 20 mA US</li> <li>■ 4 to 20 mA</li> <li>■ 0 to 20 mA (only with signal mode active)</li> <li>■ Fixed current value</li> </ul>
Open-circuit voltage	DC 28.8 V (active)
Maximum input voltage	DC 30 V (passive)
Load	250 to 700 $\Omega$
Resolution	0.38 $\mu$ A
Damping	Configurable: 0 to 999 s
Assignable measured variables	<ul style="list-style-type: none"> <li>■ Mass flow</li> <li>■ Volume flow</li> <li>■ Corrected volume flow</li> <li>■ Density</li> <li>■ Reference density</li> <li>■ Temperature</li> <li>■ Electronics temperature</li> <li>■ Oscillation frequency 0</li> <li>■ Oscillation damping 0</li> <li>■ Signal asymmetry</li> <li>■ Exciter current 0</li> </ul> <p> The range of options increases if the measuring device has one or more application packages.</p>

## Current output 4 to 20 mA HART Ex i

Order code	"Output; Input 1" (20) can be set to: <ul style="list-style-type: none"> <li>■ Option CA: current output 4 to 20 mA HART Ex i passive</li> <li>■ Option CC: current output 4 to 20 mA HART Ex i active</li> </ul>
Signal mode	Depending on the ordered variant.
Current range	Can be set to: <ul style="list-style-type: none"> <li>■ 4 to 20 mA NAMUR</li> <li>■ 4 to 20 mA US</li> <li>■ 4 to 20 mA</li> <li>■ 0 to 20 mA (only with signal mode active)</li> <li>■ Fixed current value</li> </ul>
Open-circuit voltage	DC 21.8 V (active)
Maximum input voltage	DC 30 V (passive)
Load	<ul style="list-style-type: none"> <li>■ 250 to 400 <math>\Omega</math> (active)</li> <li>■ 250 to 700 <math>\Omega</math> (passive)</li> </ul>
Resolution	0.38 $\mu$ A

<b>Damping</b>	Configurable: 0 to 999 s
<b>Assignable measured variables</b>	<ul style="list-style-type: none"> <li>▪ Mass flow</li> <li>▪ Volume flow</li> <li>▪ Corrected volume flow</li> <li>▪ Density</li> <li>▪ Reference density</li> <li>▪ Temperature</li> <li>▪ Electronics temperature</li> <li>▪ Oscillation frequency 0</li> <li>▪ Oscillation damping 0</li> <li>▪ Signal asymmetry</li> <li>▪ Exciter current 0</li> </ul> <p> The range of options increases if the measuring device has one or more application packages.</p>

**FOUNDATION Fieldbus**

<b>FOUNDATION Fieldbus</b>	H1, IEC 61158-2, galvanically isolated
<b>Data transfer</b>	31.25 kbit/s
<b>Current consumption</b>	10 mA
<b>Permitted supply voltage</b>	9 to 32 V
<b>Bus connection</b>	With integrated reverse polarity protection

**PROFIBUS DP**

<b>Signal encoding</b>	NRZ code
<b>Data transfer</b>	9.6 kBaud...12 MBaud

**PROFIBUS PA**

<b>PROFIBUS PA</b>	In accordance with EN 50170 Volume 2, IEC 61158-2 (MBP), galvanically isolated
<b>Data transmission</b>	31.25 kbit/s
<b>Current consumption</b>	10 mA
<b>Permitted supply voltage</b>	9 to 32 V
<b>Bus connection</b>	With integrated reverse polarity protection

**Modbus RS485**

<b>Physical interface</b>	RS485 in accordance with EIA/TIA-485 standard
<b>Terminating resistor</b>	Integrated, can be activated via DIP switches

**EtherNet/IP**

<b>Standards</b>	In accordance with IEEE 802.3
------------------	-------------------------------

**PROFINET**

<b>Standards</b>	In accordance with IEEE 802.3
------------------	-------------------------------

**Current output 4 to 20 mA**

<b>Order code</b>	"Output; Input 2" (21), "Output; Input 3" (022): Option B: current output 4 to 20 mA
<b>Signal mode</b>	Can be set to: <ul style="list-style-type: none"> <li>■ Active</li> <li>■ Passive</li> </ul>
<b>Current range</b>	Can be set to: <ul style="list-style-type: none"> <li>■ 4 to 20 mA NAMUR</li> <li>■ 4 to 20 mA US</li> <li>■ 4 to 20 mA</li> <li>■ 0 to 20 mA (only with signal mode active)</li> <li>■ Fixed current value</li> </ul>
<b>Maximum output values</b>	22.5 mA
<b>Open-circuit voltage</b>	DC 28.8 V (active)
<b>Maximum input voltage</b>	DC 30 V (passive)
<b>Load</b>	0 to 700 $\Omega$
<b>Resolution</b>	0.38 $\mu$ A
<b>Damping</b>	Configurable: 0 to 999 s
<b>Assignable measured variables</b>	<ul style="list-style-type: none"> <li>■ Mass flow</li> <li>■ Volume flow</li> <li>■ Corrected volume flow</li> <li>■ Density</li> <li>■ Reference density</li> <li>■ Temperature</li> <li>■ Electronics temperature</li> <li>■ Oscillation frequency 0</li> <li>■ Oscillation damping 0</li> <li>■ Signal asymmetry</li> <li>■ Exciter current 0</li> </ul> <p> The range of options increases if the measuring device has one or more application packages.</p>



**Current output 4 to 20 mA Ex i passive**

<b>Order code</b>	"Output; Input 2" (21), "Output; Input 3" (022): Option C: current output 4 to 20 mA Ex i passive
<b>Signal mode</b>	Passive
<b>Current range</b>	Can be set to: <ul style="list-style-type: none"> <li>■ 4 to 20 mA NAMUR</li> <li>■ 4 to 20 mA US</li> <li>■ 4 to 20 mA</li> <li>■ Fixed current value</li> </ul>
<b>Maximum output values</b>	22.5 mA
<b>Maximum input voltage</b>	DC 30 V
<b>Load</b>	0 to 700 $\Omega$
<b>Resolution</b>	0.38 $\mu$ A

<b>Damping</b>	Configurable: 0 to 999 s
<b>Assignable measured variables</b>	<ul style="list-style-type: none"> <li>▪ Mass flow</li> <li>▪ Volume flow</li> <li>▪ Corrected volume flow</li> <li>▪ Density</li> <li>▪ Reference density</li> <li>▪ Temperature</li> <li>▪ Electronics temperature</li> <li>▪ Oscillation frequency 0</li> <li>▪ Oscillation damping 0</li> <li>▪ Signal asymmetry</li> <li>▪ Exciter current 0</li> </ul> <p> The range of options increases if the measuring device has one or more application packages.</p>

**Pulse/frequency/switch output**

<b>Function</b>	Can be set to pulse, frequency or switch output
<b>Version</b>	<p>Open collector</p> <p>Can be set to:</p> <ul style="list-style-type: none"> <li>▪ Active</li> <li>▪ Passive</li> <li>▪ Passive NAMUR</li> </ul> <p> Ex-i, passive</p>
<b>Maximum input values</b>	DC 30 V, 250 mA (passive)
<b>Open-circuit voltage</b>	DC 28.8 V (active)
<b>Voltage drop</b>	For 22.5 mA: ≤ DC 2 V
<b>Pulse output</b>	
<b>Maximum input values</b>	DC 30 V, 250 mA (passive)
<b>Maximum output current</b>	22.5 mA (active)
<b>Open-circuit voltage</b>	DC 28.8 V (active)
<b>Pulse width</b>	Configurable: 0.05 to 2 000 ms
<b>Maximum pulse rate</b>	10 000 Impulse/s
<b>Pulse value</b>	Adjustable
<b>Assignable measured variables</b>	<ul style="list-style-type: none"> <li>▪ Mass flow</li> <li>▪ Volume flow</li> <li>▪ Corrected volume flow</li> </ul>
<b>Frequency output</b>	
<b>Maximum input values</b>	DC 30 V, 250 mA (passive)
<b>Maximum output current</b>	22.5 mA (active)
<b>Open-circuit voltage</b>	DC 28.8 V (active)
<b>Output frequency</b>	Adjustable: end value frequency 2 to 10 000 Hz ( $f_{max} = 12\,500$ Hz)
<b>Damping</b>	Configurable: 0 to 999 s
<b>Pulse/pause ratio</b>	1:1

<b>Assignable measured variables</b>	<ul style="list-style-type: none"> <li>▪ Mass flow</li> <li>▪ Volume flow</li> <li>▪ Corrected volume flow</li> <li>▪ Density</li> <li>▪ Reference density</li> <li>▪ Temperature</li> <li>▪ Electronics temperature</li> <li>▪ Oscillation frequency 0</li> <li>▪ Oscillation damping 0</li> <li>▪ Signal asymmetry</li> <li>▪ Exciter current 0</li> </ul> <p> The range of options increases if the measuring device has one or more application packages.</p>
<b>Switch output</b>	
<b>Maximum input values</b>	DC 30 V, 250 mA (passive)
<b>Open-circuit voltage</b>	DC 28.8 V (active)
<b>Switching behavior</b>	Binary, conductive or non-conductive
<b>Switching delay</b>	Configurable: 0 to 100 s
<b>Number of switching cycles</b>	Unlimited
<b>Assignable functions</b>	<ul style="list-style-type: none"> <li>▪ Off</li> <li>▪ On</li> <li>▪ Diagnostic behavior</li> <li>▪ Limit value <ul style="list-style-type: none"> <li>▪ Mass flow</li> <li>▪ Volume flow</li> <li>▪ Corrected volume flow</li> <li>▪ Density</li> <li>▪ Reference density</li> <li>▪ Temperature</li> <li>▪ Totalizer 1-3</li> </ul> </li> <li>▪ Flow direction monitoring</li> <li>▪ Status <ul style="list-style-type: none"> <li>▪ Partially filled pipe detection</li> <li>▪ Low flow cut off</li> </ul> </li> </ul> <p> The range of options increases if the measuring device has one or more application packages.</p>

**Double pulse output**

<b>Function</b>	Double pulse
<b>Version</b>	Open collector Can be set to: <ul style="list-style-type: none"> <li>▪ Active</li> <li>▪ Passive</li> <li>▪ Passive NAMUR</li> </ul>
<b>Maximum input values</b>	DC 30 V, 250 mA (passive)
<b>Open-circuit voltage</b>	DC 28.8 V (active)
<b>Voltage drop</b>	For 22.5 mA: ≤ DC 2 V
<b>Output frequency</b>	Configurable: 0 to 1000 Hz
<b>Damping</b>	Configurable: 0 to 999 s

<b>Pulse/pause ratio</b>	1:1
<b>Assignable measured variables</b>	<ul style="list-style-type: none"> <li>■ Mass flow</li> <li>■ Volume flow</li> <li>■ Corrected volume flow</li> <li>■ Density</li> <li>■ Reference density</li> <li>■ Temperature</li> </ul> <p> The range of options increases if the measuring device has one or more application packages.</p>

**Relay output**

<b>Function</b>	Switch output
<b>Version</b>	Relay output, galvanically isolated
<b>Switching behavior</b>	<p>Can be set to:</p> <ul style="list-style-type: none"> <li>■ NO (normally open), factory setting</li> <li>■ NC (normally closed)</li> </ul>
<b>Maximum switching capacity (passive)</b>	<ul style="list-style-type: none"> <li>■ DC 30 V, 0.1 A</li> <li>■ AC 30 V, 0.5 A</li> </ul>
<b>Assignable functions</b>	<ul style="list-style-type: none"> <li>■ Off</li> <li>■ On</li> <li>■ Diagnostic behavior</li> <li>■ Limit value                             <ul style="list-style-type: none"> <li>■ Mass flow</li> <li>■ Volume flow</li> <li>■ Corrected volume flow</li> <li>■ Density</li> <li>■ Reference density</li> <li>■ Temperature</li> <li>■ Totalizer 1-3</li> </ul> </li> <li>■ Flow direction monitoring</li> <li>■ Status                             <ul style="list-style-type: none"> <li>■ Partially filled pipe detection</li> <li>■ Low flow cut off</li> </ul> </li> </ul> <p> The range of options increases if the measuring device has one or more application packages.</p>

**User-configurable input/output**

**One** specific input or output is assigned to a user-configurable input/output (configurable I/O) during device commissioning.

The following inputs and outputs are available for assignment:

- Choice of current output: 4 to 20 mA (active), 0/4 to 20 mA (passive)
- Pulse/frequency/switch output
- Choice of current input: 4 to 20 mA (active), 0/4 to 20 mA (passive)
- Status input

The technical values correspond to those of the inputs and outputs described in this section.

**Signal on alarm**

Depending on the interface, failure information is displayed as follows:

**HART current output**

<b>Device diagnostics</b>	Device condition can be read out via HART Command 48
---------------------------	--

**PROFIBUS PA**

<b>Status and alarm messages</b>	Diagnostics in accordance with PROFIBUS PA Profile 3.02
<b>Failure current FDE (Fault Disconnection Electronic)</b>	0 mA

**PROFIBUS DP**

<b>Status and alarm messages</b>	Diagnostics in accordance with PROFIBUS PA Profile 3.02
----------------------------------	---

**EtherNet/IP**

<b>Device diagnostics</b>	Device condition can be read out in Input Assembly
---------------------------	--

**PROFINET**

<b>Device diagnostics</b>	According to "Application Layer protocol for decentralized periphery", Version 2.3
---------------------------	--

**FOUNDATION Fieldbus**

<b>Status and alarm messages</b>	Diagnostics in accordance with FF-891
<b>Failure current FDE (Fault Disconnection Electronic)</b>	0 mA

**Modbus RS485**

<b>Failure mode</b>	Choose from: <ul style="list-style-type: none"> <li>■ NaN value instead of current value</li> <li>■ Last valid value</li> </ul>
---------------------	---

**Current output 0/4 to 20 mA***4 to 20 mA*

<b>Failure mode</b>	Choose from: <ul style="list-style-type: none"> <li>■ 4 to 20 mA in accordance with NAMUR recommendation NE 43</li> <li>■ 4 to 20 mA in accordance with US</li> <li>■ Min. value: 3.59 mA</li> <li>■ Max. value: 22.5 mA</li> <li>■ Freely definable value between: 3.59 to 22.5 mA</li> <li>■ Actual value</li> <li>■ Last valid value</li> </ul>
---------------------	--

*0 to 20 mA*

<b>Failure mode</b>	Choose from: <ul style="list-style-type: none"> <li>■ Maximum alarm: 22 mA</li> <li>■ Freely definable value between: 0 to 20.5 mA</li> </ul>
---------------------	---



**Pulse/frequency/switch output**

Pulse output	
Failure mode	Choose from: <ul style="list-style-type: none"> <li>▪ Actual value</li> <li>▪ No pulses</li> </ul>
Frequency output	
Failure mode	Choose from: <ul style="list-style-type: none"> <li>▪ Actual value</li> <li>▪ 0 Hz</li> <li>▪ Defined value (<math>f_{max} 2</math> to 12 500 Hz)</li> </ul>
Switch output	
Failure mode	Choose from: <ul style="list-style-type: none"> <li>▪ Current status</li> <li>▪ Open</li> <li>▪ Closed</li> </ul>

**Relay output**

Failure mode	Choose from: <ul style="list-style-type: none"> <li>▪ Current status</li> <li>▪ Open</li> <li>▪ Closed</li> </ul>
--------------	---

**Local display**

Plain text display	With information on cause and remedial measures
Backlight	Red backlighting indicates a device error.

 Status signal as per NAMUR recommendation NE 107

**Interface/protocol**

- Via digital communication:
  - HART protocol
  - FOUNDATION Fieldbus
  - PROFIBUS PA
  - PROFIBUS DP
  - Modbus RS485
  - EtherNet/IP
  - PROFINET
- Via service interface
  - CDI-RJ45 service interface
  - WLAN interface

Plain text display	With information on cause and remedial measures
--------------------	---

 Additional information on remote operation →  81

**Web browser**

Plain text display	With information on cause and remedial measures
--------------------	---

## Light emitting diodes (LED)

<b>Status information</b>	<p>Status indicated by various light emitting diodes</p> <p>The following information is displayed depending on the device version:</p> <ul style="list-style-type: none"> <li>▪ Supply voltage active</li> <li>▪ Data transmission active</li> <li>▪ Device alarm/error has occurred</li> <li>▪ EtherNet/IP network available</li> <li>▪ EtherNet/IP connection established</li> <li>▪ PROFINET network available</li> <li>▪ PROFINET connection established</li> <li>▪ PROFINET blinking feature</li> </ul>
---------------------------	---

## Ex connection data

## Safety-related values

Order code for "Output; input 1"	Output type	Safety-related values "Output; input 1"	
		26 (+)	27 (-)
Option <b>BA</b>	Current output 4 to 20 mA HART	$U_N = 30 V_{DC}$ $U_M = 250 V_{AC}$	
Option <b>GA</b>	PROFIBUS PA	$U_N = 30 V_{DC}$ $U_M = 250 V_{AC}$	
Option <b>LA</b>	PROFIBUS DP	$U_N = 30 V_{DC}$ $U_M = 250 V_{AC}$	
Option <b>MA</b>	Modbus RS485	$U_N = 30 V_{DC}$ $U_M = 250 V_{AC}$	
Option <b>SA</b>	FOUNDATION Fieldbus	$U_N = 30 V_{DC}$ $U_M = 250 V_{AC}$	
Option <b>NA</b>	EtherNet/IP	$U_N = 30 V_{DC}$ $U_M = 250 V_{AC}$	
Option <b>RA</b>	PROFINET	$U_N = 30 V_{DC}$ $U_M = 250 V_{AC}$	

Order code for "Output; input 2"; "Output; input 3"	Output type	Safety-related values			
		Output; input 2		Output; input 3	
		24 (+)	25 (-)	22 (+)	23 (-)
Option <b>B</b>	Current output 4 to 20 mA	$U_N = 30 V_{DC}$ $U_M = 250 V_{AC}$			
Option <b>D</b>	User-configurable input/ output	$U_N = 30 V_{DC}$ $U_M = 250 V_{AC}$			
Option <b>E</b>	Pulse/frequency/switch output	$U_N = 30 V_{DC}$ $U_M = 250 V_{AC}$			
Option <b>F</b>	Double pulse output	$U_N = 30 V_{DC}$ $U_M = 250 V_{AC}$			
Option <b>H</b>	Relay output	$U_N = 30 V_{DC}$ $I_N = 100 mA_{DC}/500 mA_{AC}$ $U_M = 250 V_{AC}$			
Option <b>I</b>	Current input 4 to 20 mA	$U_N = 30 V_{DC}$ $U_M = 250 V_{AC}$			
Option <b>J</b>	Status input	$U_N = 30 V_{DC}$ $U_M = 250 V_{AC}$			

**Intrinsically safe values**

Order code for "Output; input 1"	Output type	Intrinsically safe values "Output; input 1"	
		26 (+)	27 (-)
Option <b>CA</b>	Current output 4 to 20 mA HART Ex i passive	$U_i = 30\text{ V}$ $I_i = 100\text{ mA}$ $P_i = 1.25\text{ W}$ $L_i = 0\text{ }\mu\text{H}$ $C_i = 6\text{ nF}$	
Option <b>CC</b>	Current output 4 to 20 mA HART Ex i active	<b>Ex ia</b> <sup>1)</sup> $U_0 = 21.8\text{ V}$ $I_0 = 90\text{ mA}$ $P_0 = 491\text{ mW}$ $L_0 = 4.1\text{ mH (IIC)}/15\text{ mH (IIB)}$ $C_0 = 160\text{ nF (IIC)}/1160\text{ nF (IIB)}$  $U_i = 30\text{ V}$ $I_i = 10\text{ mA}$ $P_i = 0.3\text{ W}$ $L_i = 5\text{ }\mu\text{H}$ $C_i = 6\text{ nF}$	<b>Ex ic</b> <sup>2)</sup> $U_0 = 21.8\text{ V}$ $I_0 = 90\text{ mA}$ $P_0 = 491\text{ mW}$ $L_0 = 9\text{ mH (IIC)}/39\text{ mH (IIB)}$ $C_0 = 600\text{ nF (IIC)}/4000\text{ nF (IIB)}$
Option <b>HA</b>	PROFIBUS PA Ex i (FISCO Field Device)	<b>Ex ia</b> <sup>3)</sup> $U_i = 30\text{ V}$ $I_i = 570\text{ mA}$ $P_i = 8.5\text{ W}$ $L_i = 10\text{ }\mu\text{H}$ $C_i = 5\text{ nF}$	<b>Ex ic</b> <sup>4)</sup> $U_i = 32\text{ V}$ $I_i = 570\text{ mA}$ $P_i = 8.5\text{ W}$ $L_i = 10\text{ }\mu\text{H}$ $C_i = 5\text{ nF}$
Option <b>TA</b>	FOUNDATION Fieldbus Ex i	<b>Ex ia</b> <sup>3)</sup> $U_i = 30\text{ V}$ $I_i = 570\text{ mA}$ $P_i = 8.5\text{ W}$ $L_i = 10\text{ }\mu\text{H}$ $C_i = 5\text{ nF}$	<b>Ex ic</b> <sup>4)</sup> $U_i = 32\text{ V}$ $I_i = 570\text{ mA}$ $P_i = 8.5\text{ W}$ $L_i = 10\text{ }\mu\text{H}$ $C_i = 5\text{ nF}$

- 1) Only available for the Zone 1; Class I, Division 1 version
- 2) Only available for the Zone 2; Class I, Division 2 version transmitter
- 3) Only available for the Zone 1; Class I, Division 1 version
- 4) Only available for the Zone 2; Class I, Division 2 version transmitter

Order code for "Output; input 2"; "Output; input 3"	Output type	Intrinsically safe values or NIFW values			
		Output; input 2		Output; input 3	
		24 (+)	25 (-)	22 (+)	23 (-)
Option <b>C</b>	Current output 4 to 20 mA Ex i	$U_i = 30\text{ V}$ $I_i = 100\text{ mA}$ $P_i = 1.25\text{ W}$ $L_i = 0$ $C_i = 0$			
Option <b>G</b>	Pulse/frequency/switch output Ex i	$U_i = 30\text{ V}$ $I_i = 100\text{ mA}$ $P_i = 1.25\text{ W}$ $L_i = 0$ $C_i = 0$			

**Low flow cut off**

The switch points for low flow cut off are user-selectable.

**Galvanic isolation**

The outputs are galvanically isolated from one another and from earth (PE).

## Protocol-specific data

## HART



Manufacturer ID	0x11
Device type ID	0x3B
HART protocol revision	7
Device description files (DTM, DD)	Information and files under: <a href="http://www.endress.com">www.endress.com</a>
HART load	Min. 250 Ω
System integration	Information on system integration: Operating Instructions →  100. <ul style="list-style-type: none"> <li>▪ Measured variables via HART protocol</li> <li>▪ Burst Mode functionality</li> </ul>

## FOUNDATION Fieldbus

Manufacturer ID	0x452B48 (hex)
Ident number	0x103B (hex)
Device revision	1
DD revision	Information and files under:
CFF revision	<ul style="list-style-type: none"> <li>▪ <a href="http://www.endress.com">www.endress.com</a></li> <li>▪ <a href="http://www.fieldbus.org">www.fieldbus.org</a></li> </ul>
Interoperability Test Kit (ITK)	Version 6.2.0
ITK Test Campaign Number	Information: <ul style="list-style-type: none"> <li>▪ <a href="http://www.endress.com">www.endress.com</a></li> <li>▪ <a href="http://www.fieldbus.org">www.fieldbus.org</a></li> </ul>
Link Master capability (LAS)	Yes
Choice of "Link Master" and "Basic Device"	Yes Factory setting: Basic Device
Node address	Factory setting: 247 (0xF7)
Supported functions	The following methods are supported: <ul style="list-style-type: none"> <li>▪ Restart</li> <li>▪ ENP Restart</li> <li>▪ Diagnostic</li> <li>▪ Set to OOS</li> <li>▪ Set to AUTO</li> <li>▪ Read trend data</li> <li>▪ Read event logbook</li> </ul>
<b>Virtual Communication Relationships (VCRs)</b>	
Number of VCRs	44
Number of link objects in VFD	50
Permanent entries	1
Client VCRs	0
Server VCRs	10
Source VCRs	43
Sink VCRs	0
Subscriber VCRs	43
Publisher VCRs	43
<b>Device Link Capabilities</b>	
Slot time	4
Min. delay between PDU	8



<b>Max. response delay</b>	16
<b>System integration</b>	Information regarding system integration: Operating Instructions →  100. <ul style="list-style-type: none"> <li>▪ Cyclic data transmission</li> <li>▪ Description of the modules</li> <li>▪ Execution times</li> <li>▪ Methods</li> </ul>

**PROFIBUS DP**

<b>Manufacturer ID</b>	0x11
<b>Ident number</b>	0x156F
<b>Profile version</b>	3.02
<b>Device description files (GSD, DTM, DD)</b>	Information and files under: <ul style="list-style-type: none"> <li>▪ <a href="http://www.endress.com">www.endress.com</a> On the product page for the device: Documents/Software → Device drivers</li> <li>▪ <a href="http://www.profibus.org">www.profibus.org</a></li> </ul>
<b>Supported functions</b>	<ul style="list-style-type: none"> <li>▪ Identification &amp; Maintenance Simplest device identification on the part of the control system and nameplate</li> <li>▪ PROFIBUS upload/download Reading and writing parameters is up to ten times faster with PROFIBUS upload/download</li> <li>▪ Condensed status Simplest and self-explanatory diagnostic information by categorizing diagnostic messages that occur</li> </ul>
<b>Configuration of the device address</b>	<ul style="list-style-type: none"> <li>▪ DIP switches on the I/O electronics module</li> <li>▪ Via operating tools (e.g. FieldCare)</li> </ul>
<b>Compatibility with earlier model</b>	<p>If the device is replaced, the measuring device Promass 300 supports the compatibility of the cyclic data with previous models. It is not necessary to adjust the engineering parameters of the PROFIBUS network with the Promass 300 GSD file.</p> <p>Previous model: Promass 83 PROFIBUS DP</p> <ul style="list-style-type: none"> <li>▪ ID No.: 1529 (hex)</li> <li>▪ Extended GSD file: EH3x1529.gsd</li> <li>▪ Standard GSD file: EH3_1529.gsd</li> </ul> <p> Description of the function scope of compatibility: Operating Instructions →  100.</p>
<b>System integration</b>	Information regarding system integration: Operating Instructions →  100. <ul style="list-style-type: none"> <li>▪ Cyclic data transmission</li> <li>▪ Block model</li> <li>▪ Description of the modules</li> </ul>





**PROFIBUS PA**

<b>Manufacturer ID</b>	0x11
<b>Ident number</b>	0x156D
<b>Profile version</b>	3.02
<b>Device description files (GSD, DTM, DD)</b>	Information and files under: <ul style="list-style-type: none"> <li>▪ <a href="http://www.endress.com">www.endress.com</a></li> <li>▪ <a href="http://www.profibus.org">www.profibus.org</a></li> </ul>

<b>Supported functions</b>	<ul style="list-style-type: none"> <li>▪ Identification &amp; Maintenance Simplest device identification on the part of the control system and nameplate</li> <li>▪ PROFIBUS upload/download Reading and writing parameters is up to ten times faster with PROFIBUS upload/download</li> <li>▪ Condensed status Simplest and self-explanatory diagnostic information by categorizing diagnostic messages that occur</li> </ul>
<b>Configuration of the device address</b>	<ul style="list-style-type: none"> <li>▪ DIP switches on the I/O electronics module</li> <li>▪ Local display</li> <li>▪ Via operating tools (e.g. FieldCare)</li> </ul>
<b>Compatibility with earlier model</b>	<p>If the device is replaced, the measuring device Promass 300 supports the compatibility of the cyclic data with previous models. It is not necessary to adjust the engineering parameters of the PROFIBUS network with the Promass 300 GSD file.</p> <p>Earlier models:</p> <ul style="list-style-type: none"> <li>▪ Promass 80 PROFIBUS PA <ul style="list-style-type: none"> <li>▪ ID No.: 1528 (hex)</li> <li>▪ Extended GSD file: EH3x1528.gsd</li> <li>▪ Standard GSD file: EH3_1528.gsd</li> </ul> </li> <li>▪ Promass 83 PROFIBUS PA <ul style="list-style-type: none"> <li>▪ ID No.: 152A (hex)</li> <li>▪ Extended GSD file: EH3x152A.gsd</li> <li>▪ Standard GSD file: EH3_152A.gsd</li> </ul> </li> </ul> <p> Description of the function scope of compatibility: Operating Instructions →  100.</p>
<b>System integration</b>	<p>Information regarding system integration: Operating Instructions →  100.</p> <ul style="list-style-type: none"> <li>▪ Cyclic data transmission</li> <li>▪ Block model</li> <li>▪ Description of the modules</li> </ul>

### Modbus RS485

<b>Protocol</b>	Modbus Applications Protocol Specification V1.1
<b>Response times</b>	<ul style="list-style-type: none"> <li>▪ Direct data access: typically 25 to 50 ms</li> <li>▪ Auto-scan buffer (data range): typically 3 to 5 ms</li> </ul>
<b>Device type</b>	Slave
<b>Slave address range</b>	1 to 247
<b>Broadcast address range</b>	0
<b>Function codes</b>	<ul style="list-style-type: none"> <li>▪ 03: Read holding register</li> <li>▪ 04: Read input register</li> <li>▪ 06: Write single registers</li> <li>▪ 08: Diagnostics</li> <li>▪ 16: Write multiple registers</li> <li>▪ 23: Read/write multiple registers</li> </ul>
<b>Broadcast messages</b>	<p>Supported by the following function codes:</p> <ul style="list-style-type: none"> <li>▪ 06: Write single registers</li> <li>▪ 16: Write multiple registers</li> <li>▪ 23: Read/write multiple registers</li> </ul>
<b>Supported baud rate</b>	<ul style="list-style-type: none"> <li>▪ 1 200 BAUD</li> <li>▪ 2 400 BAUD</li> <li>▪ 4 800 BAUD</li> <li>▪ 9 600 BAUD</li> <li>▪ 19 200 BAUD</li> <li>▪ 38 400 BAUD</li> <li>▪ 57 600 BAUD</li> <li>▪ 115 200 BAUD</li> </ul>
<b>Data transfer mode</b>	<ul style="list-style-type: none"> <li>▪ ASCII</li> <li>▪ RTU</li> </ul>

<b>Data access</b>	Each device parameter can be accessed via Modbus RS485.  For Modbus register information
<b>Compatibility with earlier model</b>	If the device is replaced, the measuring device Promass 300 supports the compatibility of the Modbus registers for the process variables and the diagnostic information with the previous model Promass 83. It is not necessary to change the engineering parameters in the automation system.  Description of the function scope of compatibility: Operating Instructions →  100.
<b>System integration</b>	Information on system integration: Operating Instructions →  100. <ul style="list-style-type: none"> <li>▪ Modbus RS485 information</li> <li>▪ Function codes</li> <li>▪ Register information</li> <li>▪ Response time</li> <li>▪ Modbus data map</li> </ul>

### EtherNet/IP

<b>Protocol</b>	<ul style="list-style-type: none"> <li>▪ The CIP Networks Library Volume 1: Common Industrial Protocol</li> <li>▪ The CIP Networks Library Volume 2: EtherNet/IP Adaptation of CIP</li> </ul>
<b>Communication type</b>	<ul style="list-style-type: none"> <li>▪ 10Base-T</li> <li>▪ 100Base-TX</li> </ul>
<b>Device profile</b>	Generic device (product type: 0x2B)
<b>Manufacturer ID</b>	0x11
<b>Device type ID</b>	0x103B
<b>Baud rates</b>	Automatic <sup>10</sup> / <sub>100</sub> Mbit with half-duplex and full-duplex detection
<b>Polarity</b>	Auto-polarity for automatic correction of crossed Tx/D and Rx/D pairs
<b>Supported CIP connections</b>	Max. 3 connections
<b>Explicit connections</b>	Max. 6 connections
<b>I/O connections</b>	Max. 6 connections (scanner)
<b>Configuration options for measuring device</b>	<ul style="list-style-type: none"> <li>▪ DIP switches on the electronics module for IP addressing</li> <li>▪ Manufacturer-specific software (FieldCare)</li> <li>▪ Add-on Profile Level 3 for Rockwell Automation control systems</li> <li>▪ Web browser</li> <li>▪ Electronic Data Sheet (EDS) integrated in the measuring device</li> </ul>
<b>Configuration of the EtherNet interface</b>	<ul style="list-style-type: none"> <li>▪ Speed: 10 MBit, 100 MBit, auto (factory setting)</li> <li>▪ Duplex: half-duplex, full-duplex, auto (factory setting)</li> </ul>
<b>Configuration of the device address</b>	<ul style="list-style-type: none"> <li>▪ DIP switches on the electronics module for IP addressing (last octet)</li> <li>▪ DHCP</li> <li>▪ Manufacturer-specific software (FieldCare)</li> <li>▪ Add-on Profile Level 3 for Rockwell Automation control systems</li> <li>▪ Web browser</li> <li>▪ EtherNet/IP tools, e.g. RSLinx (Rockwell Automation)</li> </ul>
<b>Device Level Ring (DLR)</b>	Yes
<b>System integration</b>	Information regarding system integration: Operating Instructions →  100. <ul style="list-style-type: none"> <li>▪ Cyclic data transmission</li> <li>▪ Block model</li> <li>▪ Input and output groups</li> </ul>

### PROFINET

<b>Protocol</b>	Application layer protocol for decentral device periphery and distributed automation, Version 2.3
<b>Communication type</b>	100 MBit/s

<b>Conformity class</b>	Conformance Class B
<b>Netload Class</b>	Netload Class II
<b>Baud rates</b>	Automatic 100 Mbit/s with full-duplex detection
<b>Cycle times</b>	From 8 ms
<b>Polarity</b>	Auto-polarity for automatic correction of crossed TxD and RxD pairs
<b>Media Redundancy Protocol (MRP)</b>	Yes
<b>System redundancy support</b>	System redundancy S2 (2 AR with 1 NAP)
<b>Device profile</b>	Application interface identifier 0xF600 Generic device
<b>Manufacturer ID</b>	0x11
<b>Device type ID</b>	0x843B
<b>Device description files (GSD, DTM, DD)</b>	Information and files under: <ul style="list-style-type: none"> <li>▪ <a href="http://www.endress.com">www.endress.com</a></li> <li>On the product page for the device: Documents/Software → Device drivers</li> <li>▪ <a href="http://www.profibus.org">www.profibus.org</a></li> </ul>
<b>Supported connections</b>	<ul style="list-style-type: none"> <li>▪ 2 x AR (IO Controller AR)</li> <li>▪ 1 x AR (IO-Supervisor Device AR connection allowed)</li> <li>▪ 1 x Input CR (Communication Relation)</li> <li>▪ 1 x Output CR (Communication Relation)</li> <li>▪ 1 x Alarm CR (Communication Relation)</li> </ul>
<b>Configuration options for measuring device</b>	<ul style="list-style-type: none"> <li>▪ DIP switches on the electronics module, for device name assignment (last part)</li> <li>▪ Manufacturer-specific software (FieldCare, DeviceCare)</li> <li>▪ Web browser</li> <li>▪ Device master file (GSD), can be read out via the integrated Web server of the measuring device</li> </ul>
<b>Configuration of the device name</b>	<ul style="list-style-type: none"> <li>▪ DIP switches on the electronics module, for device name assignment (last part)</li> <li>▪ DCP protocol</li> <li>▪ Process Device Manager (PDM)</li> <li>▪ Integrated Web server</li> </ul>
<b>Supported functions</b>	<ul style="list-style-type: none"> <li>▪ Identification &amp; Maintenance</li> <li>Simple device identification via: <ul style="list-style-type: none"> <li>▪ Control system</li> <li>▪ Nameplate</li> </ul> </li> <li>▪ Measured value status</li> <li>The process variables are communicated with a measured value status</li> <li>▪ Blinking feature via the onsite display for simple device identification and assignment</li> <li>▪ Device operation via operating tools (e.g. FieldCare, DeviceCare, SIMATIC PDM)</li> </ul>
<b>System integration</b>	Information regarding system integration: Operating Instructions →  100. <ul style="list-style-type: none"> <li>▪ Cyclic data transmission</li> <li>▪ Overview and description of the modules</li> <li>▪ Status coding</li> <li>▪ Startup configuration</li> <li>▪ Factory setting</li> </ul>



## Power supply

### Terminal assignment

#### Transmitter: supply voltage, input/outputs

##### HART

Supply voltage		Input/output 1		Input/output 2		Input/output 3	
1 (+)	2 (-)	26 (+)	27 (-)	24 (+)	25 (-)	22 (+)	23 (-)
The terminal assignment depends on the specific device version ordered → 12.							

##### FOUNDATION Fieldbus

Supply voltage		Input/output 1		Input/output 2		Input/output 3	
1 (+)	2 (-)	26 (A)	27 (B)	24 (+)	25 (-)	22 (+)	23 (-)
The terminal assignment depends on the specific device version ordered → 12.							

##### PROFIBUS PA

Supply voltage		Input/output 1		Input/output 2		Input/output 3	
1 (+)	2 (-)	26 (B)	27 (A)	24 (+)	25 (-)	22 (+)	23 (-)
The terminal assignment depends on the specific device version ordered → 12.							

##### PROFIBUS DP

Supply voltage		Input/output 1		Input/output 2		Input/output 3	
1 (+)	2 (-)	26 (B)	27 (A)	24 (+)	25 (-)	22 (+)	23 (-)
The terminal assignment depends on the specific device version ordered → 12.							

##### Modbus RS485

Supply voltage		Input/output 1		Input/output 2		Input/output 3	
1 (+)	2 (-)	26 (B)	27 (A)	24 (+)	25 (-)	22 (+)	23 (-)
The terminal assignment depends on the specific device version ordered → 12.							

##### PROFINET

Supply voltage		Input/output 1		Input/output 2		Input/output 3	
1 (+)	2 (-)	PROFINET (RJ45 connector)		24 (+)	25 (-)	22 (+)	23 (-)
The terminal assignment depends on the specific device version ordered → 12.							

##### EtherNet/IP

Supply voltage		Input/output 1		Input/output 2		Input/output 3	
1 (+)	2 (-)	EtherNet/IP (RJ45 connector)		24 (+)	25 (-)	22 (+)	23 (-)
The terminal assignment depends on the specific device version ordered → 12.							

 Terminal assignment of the remote display and operating module → 32.

### Device plugs available

 Device plugs may not be used in hazardous areas!

**Device plugs for fieldbus systems:**

Order code for "Input; output 1"

- Option SA "FOUNDATION Fieldbus" → 30
- Option GA "PROFIBUS PA" → 30
- Option NA "EtherNet/IP" → 30
- Option RA "PROFINET" → 30

**Device plug for connecting to the service interface:**

Order code for "Accessory mounted"

option NB, adapter RJ45 M12 (service interface) → 42

**Order code for "Input; output 1", option SA "FOUNDATION Fieldbus"**

Order code for "Electrical connection"	Cable entry/connection → 31	
	2	3
M, 3, 4, 5	7/8" connector	-

**Order code for "Input; output 1", option GA "PROFIBUS PA"**

Order code for "Electrical connection"	Cable entry/connection → 31	
	2	3
L, N, P, U	Connector M12 × 1	-

**Order code for "Input; output 1", option NA "EtherNet/IP"**

Order code for "Electrical connection"	Cable entry/connection → 31	
	2	3
L, N, P, U	Connector M12 × 1	-
R <sup>1) 2)</sup> , S <sup>1) 2)</sup> , T <sup>1) 2)</sup> , V <sup>1) 2)</sup>	Connector M12 × 1	Connector M12 × 1

1) Cannot be combined with an external WLAN antenna (order code for "Enclosed accessories", option P8) of an RJ45 M12 adapter for the service interface (order code for "Accessories mounted", option NB) or of the remote display and operating module DKX001

2) Suitable for integrating the device in a ring topology.

**Order code for "Input; output 1", option RA "PROFINET"**

Order code for "Electrical connection"	Cable entry/connection → 31	
	2	3
L, N, P, U	Connector M12 × 1	-
R <sup>1) 2)</sup> , S <sup>1) 2)</sup> , T <sup>1) 2)</sup> , V <sup>1) 2)</sup>	Connector M12 × 1	Connector M12 × 1

1) Cannot be combined with an external WLAN antenna (order code for "Enclosed accessories", option P8) of an RJ45 M12 adapter for the service interface (order code for "Accessories mounted", option NB) or of the remote display and operating module DKX001.

2) Suitable for integrating the device in a ring topology.

**Order code for "Accessory mounted", option NB "Adapter RJ45 M12 (service interface)"**

Order code "Accessory mounted"	Cable entry/coupling → 31	
	Cable entry 2	Cable entry 3
NB	Plug M12 × 1	-

Supply voltage	Order code for "Power supply"	Terminal voltage		Frequency range
	Option D	DC24 V	±20%	-
Option E	AC100 to 240 V	-15...+10%	50/60 Hz	
Option I	DC24 V	±20%	-	
	AC100 to 240 V	-15...+10%	50/60 Hz	

**Power consumption** **Transmitter**  
 Max. 10 W (active power)

<b>switch-on current</b>	Max. 36 A (<5 ms) as per NAMUR Recommendation NE 21
--------------------------	---

**Current consumption** **Transmitter**

- Max. 400 mA (24 V)
- Max. 200 mA (110 V, 50/60 Hz; 230 V, 50/60 Hz)

**Power supply failure**

- Totalizers stop at the last value measured.
- Depending on the device version, the configuration is retained in the device memory or in the pluggable data memory (HistoROM DAT).
- Error messages (incl. total operated hours) are stored.

**Electrical connection** **Connecting the transmitter**

- Terminal assignment → 29
- Device plugs available → 29

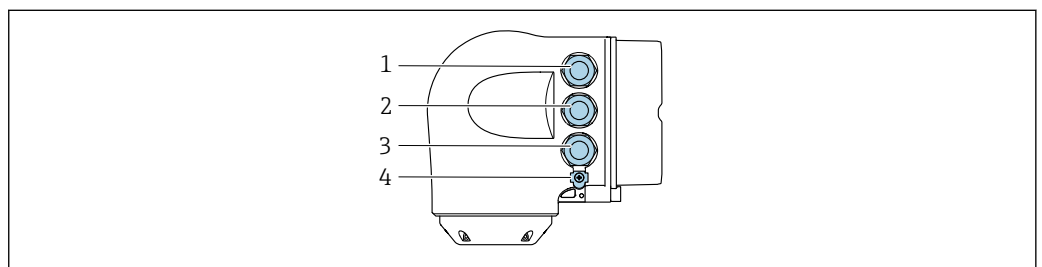

- 1 Terminal connection for supply voltage
- 2 Terminal connection for signal transmission, input/output
- 3 Terminal connection for signal transmission, input/output or terminal for network connection via service interface (CDI-RJ45); Optional: terminal connection for external WLAN antenna or connection for remote display and operating module DKX001
- 4 Protective ground (PE)

**i** An adapter for RJ45 and the M12 connector is optionally available:  
 Order code for "Accessories", option **NB**: "Adapter RJ45 M12 (service interface)"

The adapter connects the service interface (CDI-RJ45) to an M12 connector mounted in the cable entry. Therefore the connection to the service interface can be established via an M12 connector without opening the device.

**i** Network connection via service interface (CDI-RJ45) → 86

*Connecting in a ring topology*

Device versions with EtherNet/IP and PROFINET communication protocols can be integrated into a ring topology. The device is integrated via the terminal connection for signal transmission (output 1) and the connection to the service interface (CDI-RJ45).

**i** Integrate the transmitter into a ring topology:

- EtherNet/IP
- PROFINET

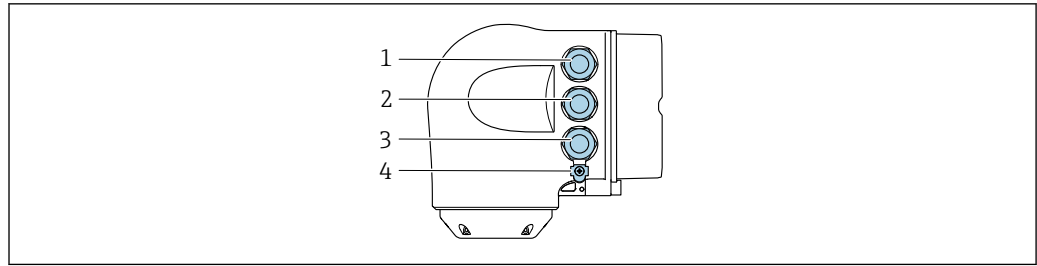

A0026781

- 1 Terminal connection for supply voltage
- 2 Terminal connection for signal transmission: PROFINET or EtherNet/IP (RJ45 connector)
- 3 Connection to service interface (CDI-RJ45)
- 4 Protective ground (PE)

**i** If the device has additional input/outputs, these are routed via the cable entry for the connection to the service interface (CDI-RJ45).

### Connecting the remote display and operating module DKX001

**i** The remote display and operating module DKX001 is available as an optional extra → 96.

- The remote display and operating module DKX001 is only available for the following housing version: order code for "Housing": option A "Aluminum, coated"
- The measuring device is always supplied with a dummy cover when the remote display and operating module DKX001 is ordered directly with the measuring device. Display or operation at the transmitter is not possible in this case.
- If ordered subsequently, the remote display and operating module DKX001 may not be connected at the same time as the existing measuring device display module. Only one display or operation unit may be connected to the transmitter at any one time.

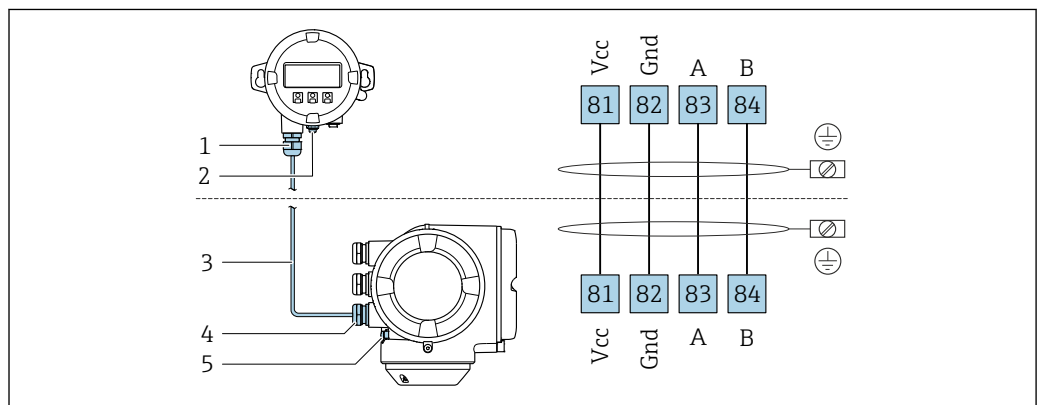

A0027518

- 1 Remote display and operating module DKX001
- 2 Protective earth (PE)
- 3 Connecting cable
- 4 Measuring device
- 5 Protective earth (PE)

Connection examples

Current output 4 to 20 mA HART

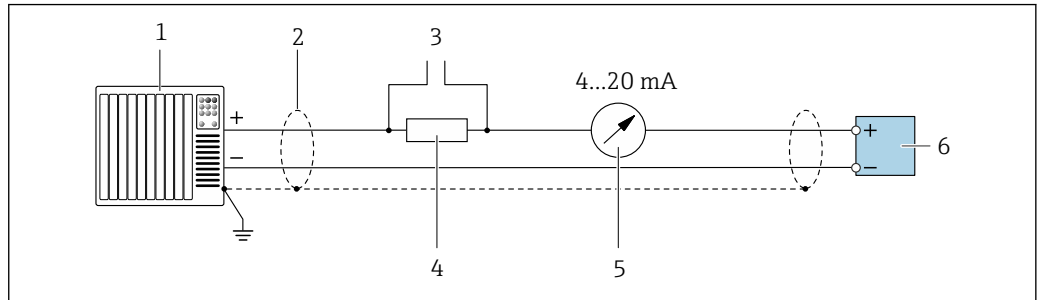

A0029055

2 Connection example for 4 to 20 mA HART current output (active)

- 1 Automation system with current input (e.g. PLC)
- 2 Cable shield provided at one end. The cable shield must be grounded at both ends to comply with EMC requirements; observe cable specifications → 42
- 3 Connection for HART operating devices → 81
- 4 Resistor for HART communication ( $\geq 250 \Omega$ ); observe maximum load → 14
- 5 Analog display unit: observe maximum load → 14
- 6 Transmitter

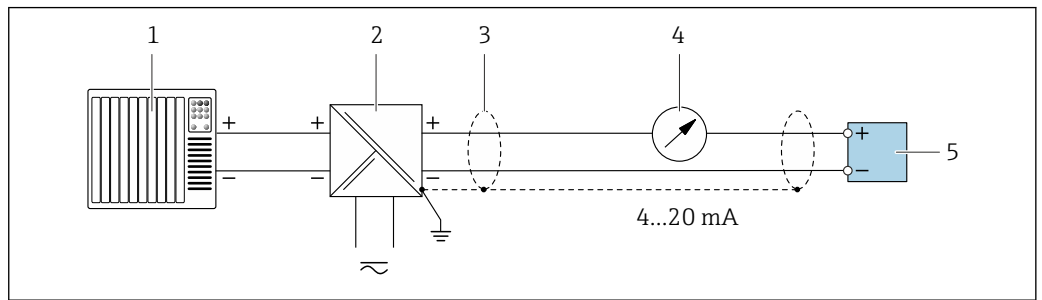

A0028762

3 Connection example for 4 to 20 mA HART current output (passive)

- 1 Automation system with current input (e.g. PLC)
- 2 Power supply
- 3 Cable shield provided at one end. The cable shield must be grounded at both ends to comply with EMC requirements; observe cable specifications → 42
- 4 Analog display unit: observe maximum load → 14
- 5 Transmitter

HART input

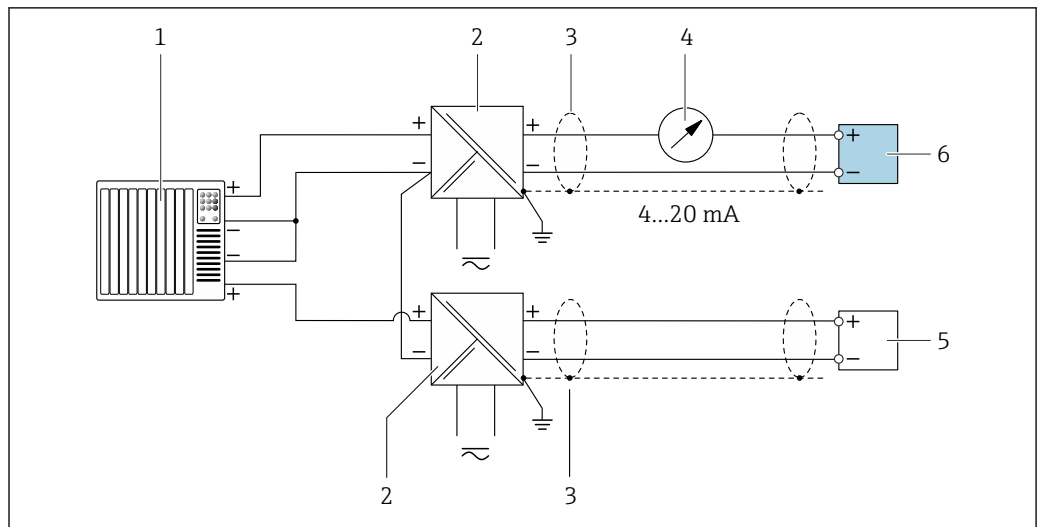

A0028763

4 Connection example for HART input with a common negative (passive)

- 1 Automation system with HART output (e.g. PLC)
- 2 Active barrier for power supply (e.g. RN221N)
- 3 Cable shield provided at one end. The cable shield must be grounded at both ends to comply with EMC requirements; observe cable specifications
- 4 Analog display unit: observe maximum load → 14
- 5 Pressure measuring device (e.g. Cerabar M, Cerabar S): see requirements
- 6 Transmitter

PROFIBUS PA

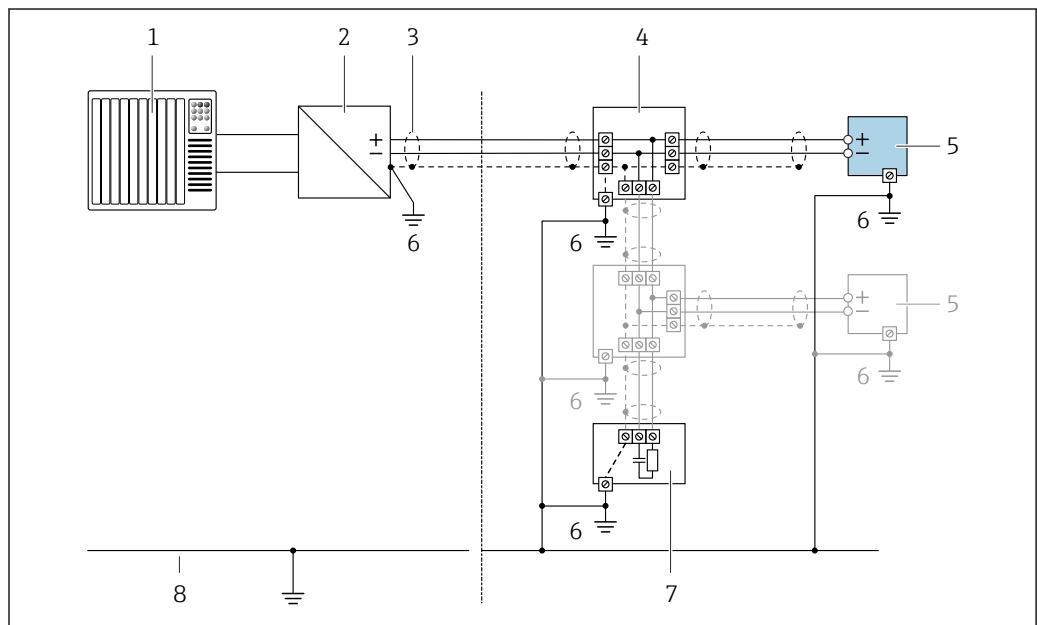

A0028768

5 Connection example for PROFIBUS PA

- 1 Control system (e.g. PLC)
- 2 PROFIBUS PA segment coupler
- 3 Cable shield provided at one end. The cable shield must be grounded at both ends to comply with EMC requirements; observe cable specifications
- 4 T-box
- 5 Measuring device
- 6 Local grounding
- 7 Bus terminator
- 8 Potential matching line

PROFIBUS DP

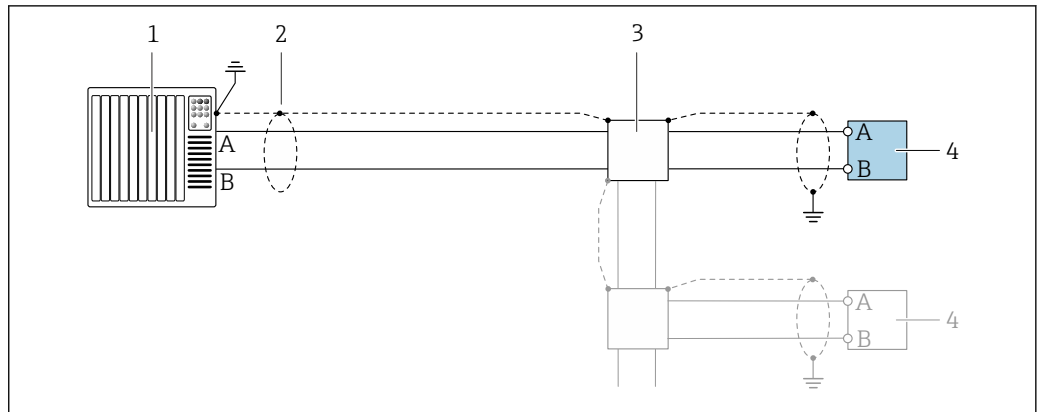

A0028765

6 Connection example for PROFIBUS DP, non-hazardous area and Zone 2/Div. 2

- 1 Control system (e.g. PLC)
- 2 Cable shield provided at one end. The cable shield must be grounded at both ends to comply with EMC requirements; observe cable specifications
- 3 Distribution box
- 4 Transmitter

**i** If baud rates > 1.5 MBaud an EMC cable entry must be used and the cable shield must continue as far as the terminal wherever possible.

EtherNet/IP

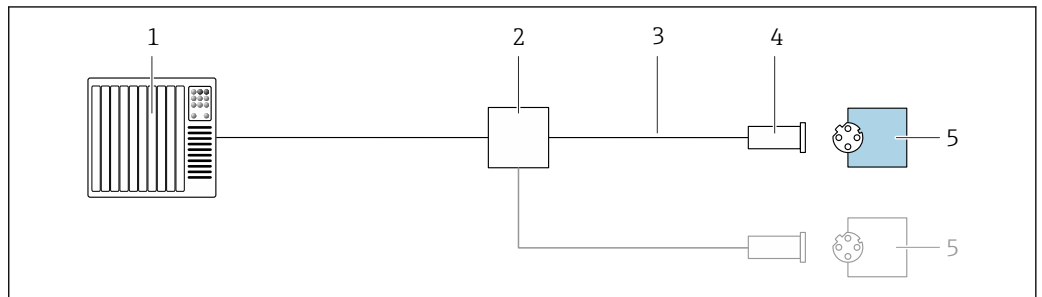

A0028767

7 Connection example for EtherNet/IP

- 1 Control system (e.g. PLC)
- 2 Ethernet switch
- 3 Observe cable specifications
- 4 Device plug
- 5 Transmitter

*EtherNet/IP: DLR (Device Level Ring)*

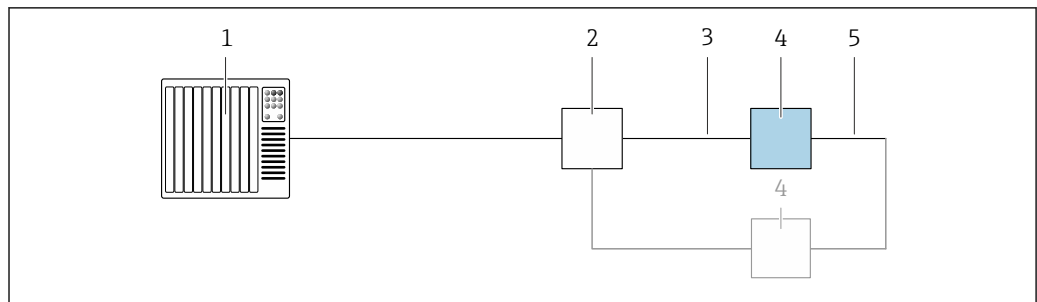

A0027544

- 1 Control system (e.g. PLC)
- 2 Ethernet switch
- 3 Observe cable specifications → 43
- 4 Transmitter
- 5 Connecting cable between the two transmitters

*PROFINET*

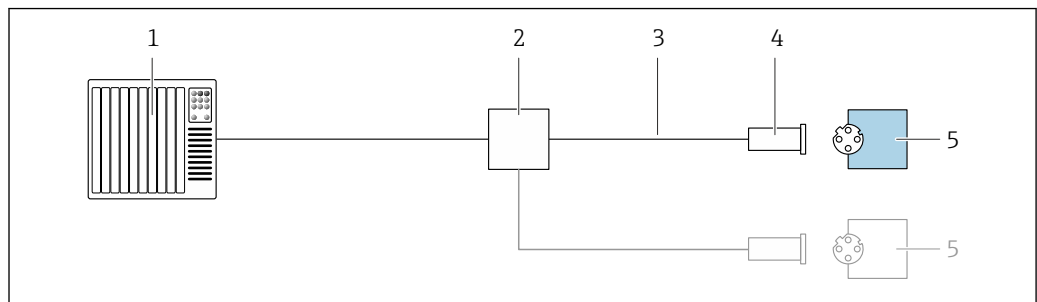

A0028767

8 Connection example for PROFINET

- 1 Control system (e.g. PLC)
- 2 Ethernet switch
- 3 Observe cable specifications
- 4 Device plug
- 5 Transmitter

*PROFINET: MRP (Media Redundancy Protocol)*

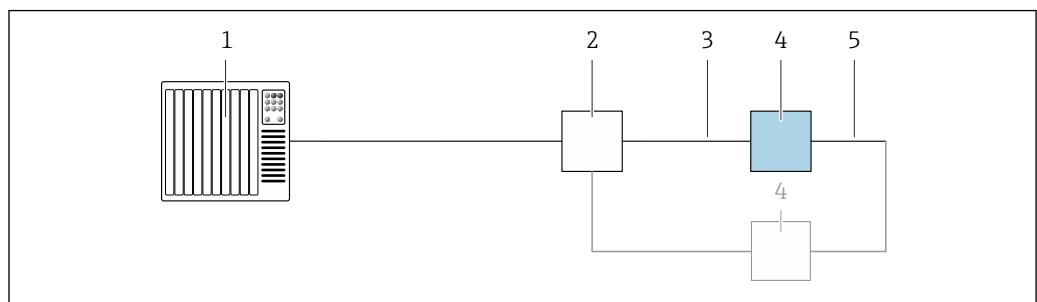

A0027544

- 1 Control system (e.g. PLC)
- 2 Ethernet switch
- 3 Observe cable specifications → 43
- 4 Transmitter
- 5 Connecting cable between the two transmitters



PROFINET: system redundancy S2

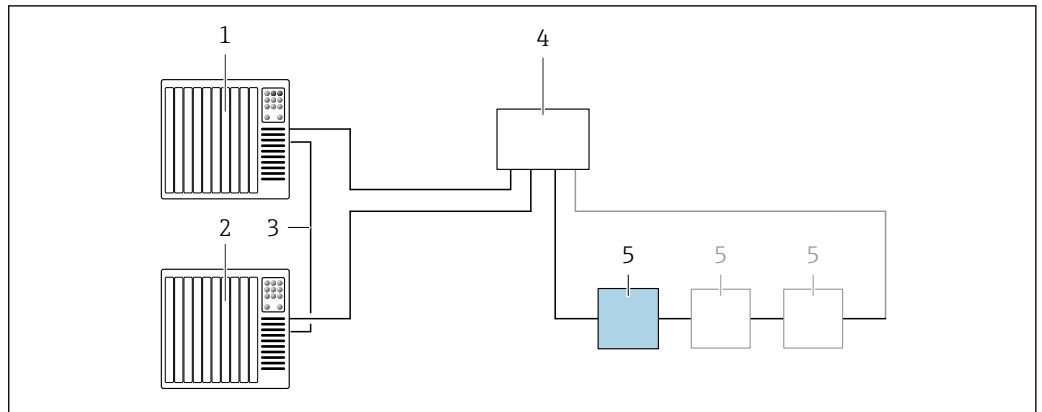

A0039553

9 Connection example for system redundancy S2

- 1 Control system 1 (e.g. PLC)
- 2 Synchronization of control systems
- 3 Control system 2 (e.g. PLC)
- 4 Industrial Ethernet Managed Switch
- 5 Transmitter

FOUNDATION Fieldbus

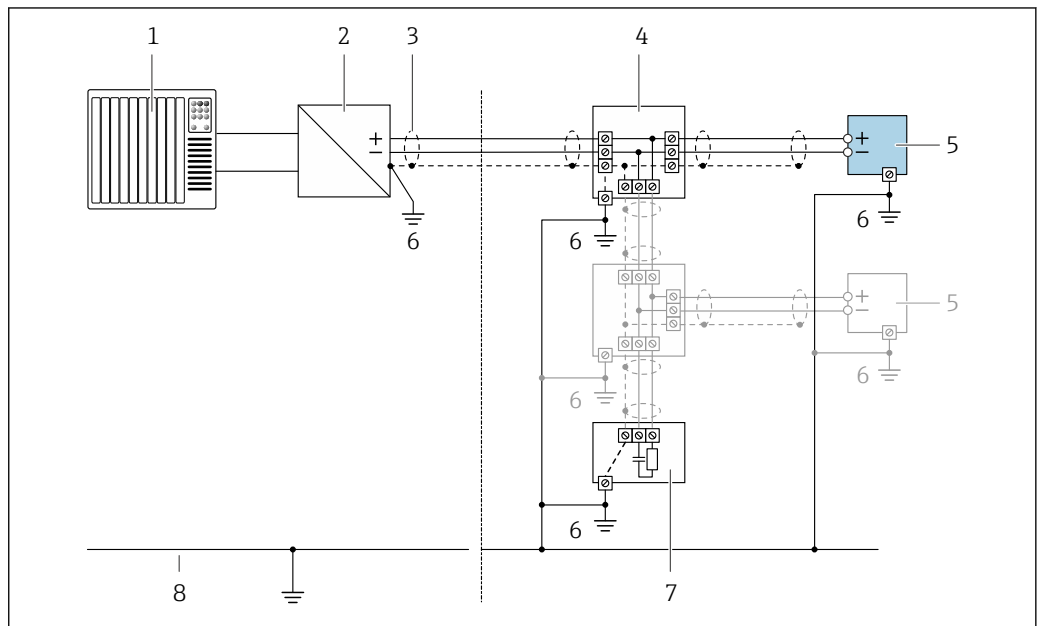

A0028768

10 Connection example for FOUNDATION Fieldbus

- 1 Control system (e.g. PLC)
- 2 Power Conditioner (FOUNDATION Fieldbus)
- 3 Cable shield provided at one end. The cable shield must be grounded at both ends to comply with EMC requirements; observe cable specifications
- 4 T-box
- 5 Measuring device
- 6 Local grounding
- 7 Bus terminator
- 8 Potential matching line

Modbus RS485

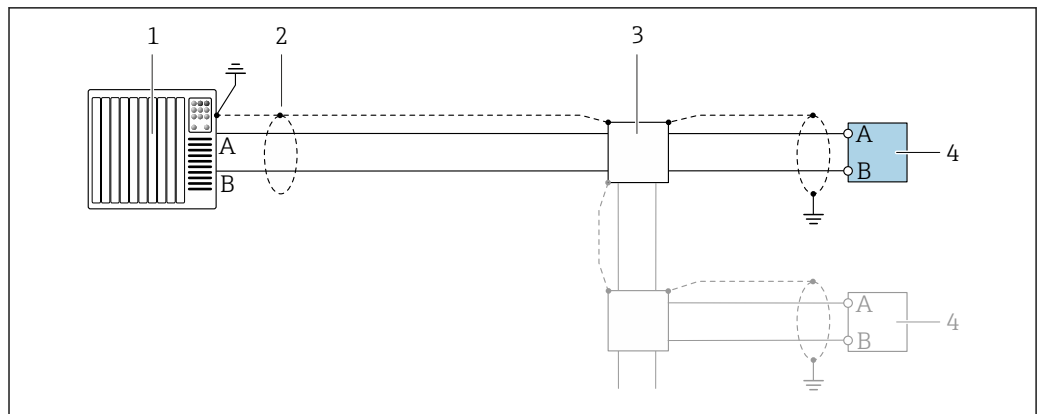

A0028765

11 Connection example for Modbus RS485, non-hazardous area and Zone 2; Class I, Division 2

- 1 Control system (e.g. PLC)
- 2 Cable shield provided at one end. The cable shield must be grounded at both ends to comply with EMC requirements; observe cable specifications
- 3 Distribution box
- 4 Transmitter

Current output 4-20 mA

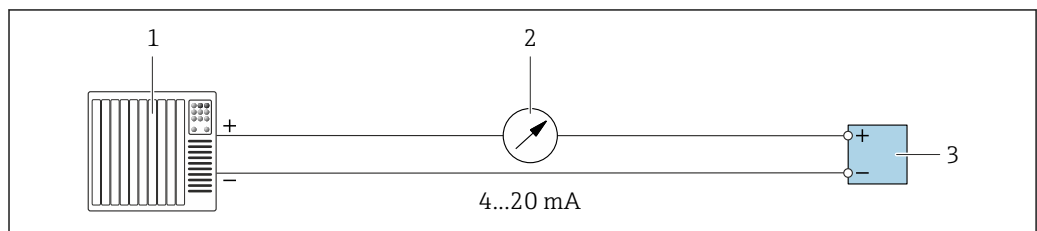

A0028758

12 Connection example for 4-20 mA current output (active)

- 1 Automation system with current input (e.g. PLC)
- 2 Analog display unit: observe maximum load → 14
- 3 Transmitter

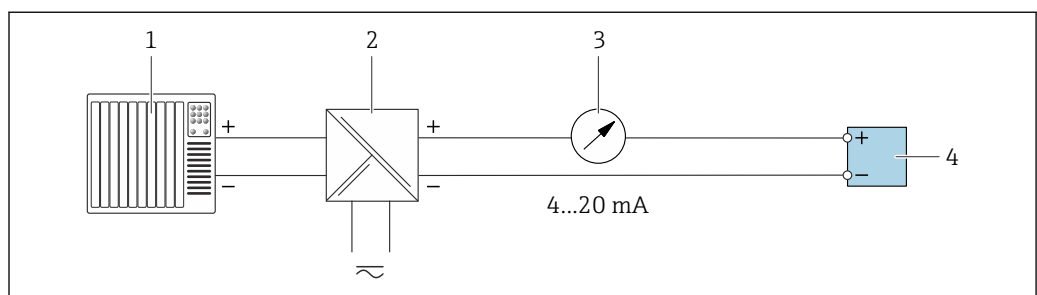

A0028759

13 Connection example for 4-20 mA current output (passive)

- 1 Automation system with current input (e.g. PLC)
- 2 Active barrier for power supply (e.g. RN221N)
- 3 Analog display unit: observe maximum load → 14
- 4 Transmitter

Pulse/frequency output

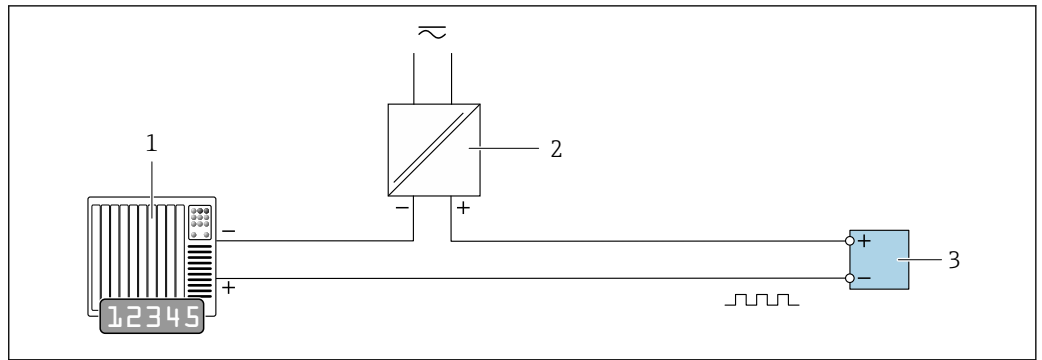

A0028761

- 14 Connection example for pulse/frequency output (passive)
- 1 Automation system with pulse/frequency input (e.g. PLC)
  - 2 Power supply
  - 3 Transmitter: Observe input values → 17

Switch output

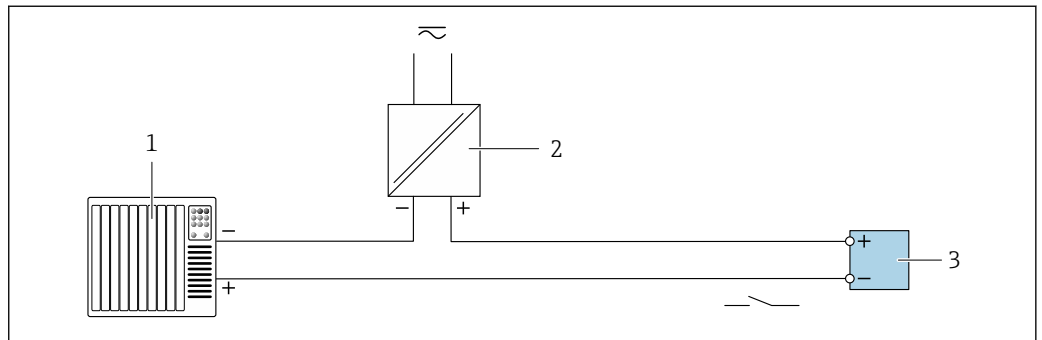

A0028760

- 15 Connection example for switch output (passive)
- 1 Automation system with switch input (e.g. PLC)
  - 2 Power supply
  - 3 Transmitter: Observe input values → 17

Double pulse output

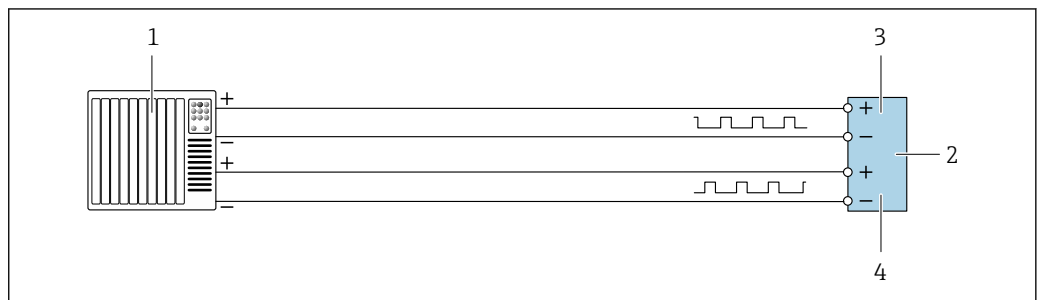

A0029280

- 16 Connection example for double pulse output (active)
- 1 Automation system with double pulse input (e.g. PLC)
  - 2 Transmitter: Observe input values → 18
  - 3 Double pulse output
  - 4 Double pulse output (slave), phase-shifted

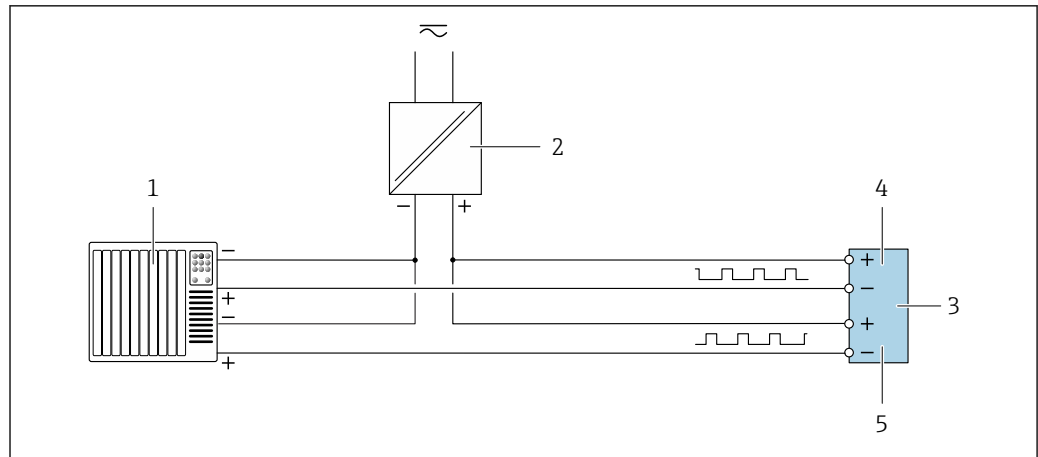

A0029279

17 Connection example for double pulse output (passive)

- 1 Automation system with double pulse input (e.g. PLC)
- 2 Power supply
- 3 Transmitter: Observe input values → 18
- 4 Double pulse output
- 5 Double pulse output (slave), phase-shifted

Relay output

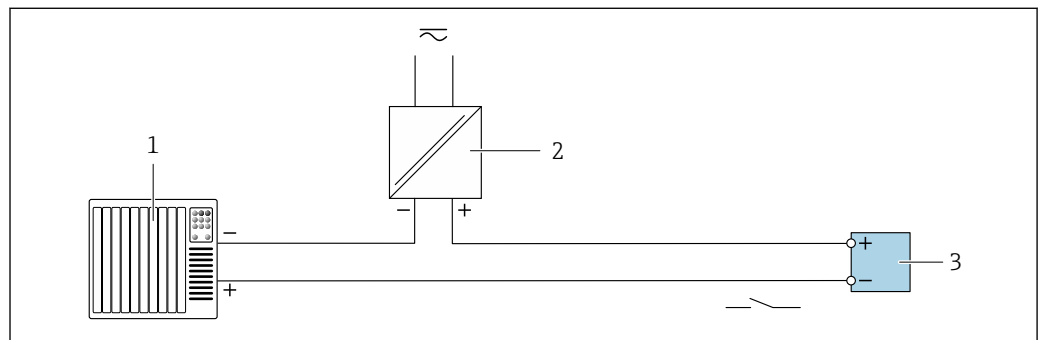

A0028760

18 Connection example for relay output (passive)

- 1 Automation system with relay input (e.g. PLC)
- 2 Power supply
- 3 Transmitter: Observe input values → 19

Current input

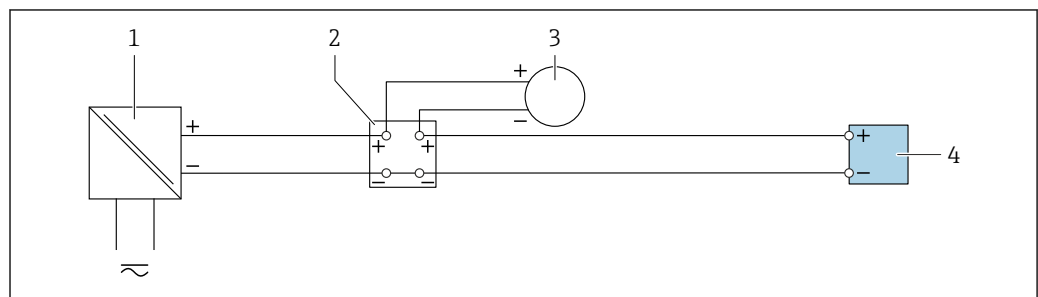

A0028915

19 Connection example for 4 to 20 mA current input

- 1 Power supply
- 2 Terminal box
- 3 External measuring device (to read in pressure or temperature, for instance)
- 4 Transmitter

Status input

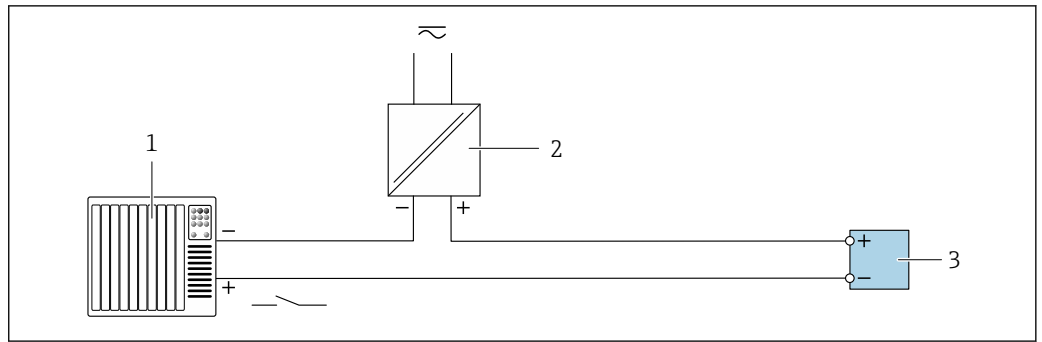

A0028764

20 Connection example for status input

- 1 Automation system with status output (e.g. PLC)
- 2 Power supply
- 3 Transmitter

Potential equalization

Requirements

No special measures for potential equalization are required.

Please consider the following to ensure correct measurement:

- Same electrical potential for the fluid and sensor
- Company-internal grounding concepts

Terminals

Spring-loaded terminals: Suitable for strands and strands with ferrules.  
 Conductor cross-section 0.2 to 2.5 mm<sup>2</sup> (24 to 12 AWG).

Cable entries

- Cable gland: M20 × 1.5 with cable  $\varnothing$  6 to 12 mm (0.24 to 0.47 in)
- Thread for cable entry:
  - NPT 1/2"
  - G 1/2"
  - M20
- Device plug for digital communication: M12  
 Only available for certain device versions → 29.

Pin assignment, device plug

FOUNDATION Fieldbus

Pin	Assignment		Coding	Plug/socket
	Pin	Assignment		
1	+	Signal +	A	Plug
2	-	Signal -		
3		Grounding		
4		Not assigned		

PROFIBUS PA

Pin	Assignment		Coding	Plug/socket
	Pin	Assignment		
1	+	PROFIBUS PA +	A	Plug
2		Grounding		
3	-	PROFIBUS PA -		
4		Not assigned		

**PROFINET**

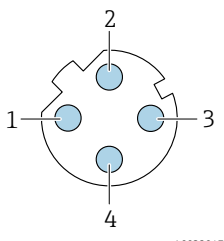
	Pin		Assignment	
	1	+		TD +
	2	+		RD +
	3	-		TD -
	4	-		RD -
	Coding		Plug/socket	
D		Socket		



Recommended plug:

- Binder, series 763, part no. 99 3729 810 04
- Phoenix, part no. 1543223 SACC-M12MSD-4Q

**EtherNet/IP**

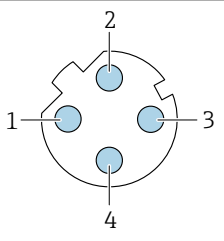
	Pin		Assignment	
	1	+		Tx
	2	+		Rx
	3	-		Tx
	4	-		Rx
	Coding		Plug/socket	
D		Socket		



Recommended plug:

- Binder, series 763, part no. 99 3729 810 04
- Phoenix, part no. 1543223 SACC-M12MSD-4Q

**Service interface**Order code for "Accessories mounted", option **NB**: Adapter RJ45 M12 (service interface)

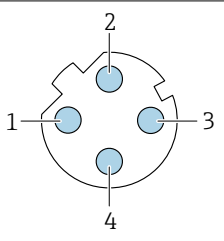
	Pin		Assignment	
	1	+		Tx
	2	+		Rx
	3	-		Tx
	4	-		Rx
	Coding		Plug/socket	
D		Socket		



Recommended plug:

- Binder, series 763, part no. 99 3729 810 04
- Phoenix, part no. 1543223 SACC-M12MSD-4Q

**Cable specification****Permitted temperature range**

- The installation guidelines that apply in the country of installation must be observed.
- The cables must be suitable for the minimum and maximum temperatures to be expected.

**Power supply cable**

Standard installation cable is sufficient.

**Signal cable**

*Current output 4 to 20 mA HART*

A shielded cable is recommended. Observe grounding concept of the plant.

*PROFIBUS PA*

Twisted, shielded two-wire cable. Cable type A is recommended .



For further information on planning and installing PROFIBUS networks see:

- Operating Instructions "PROFIBUS DP/PA: Guidelines for planning and commissioning" (BA00034S)
- PNO Directive 2.092 "PROFIBUS PA User and Installation Guideline"
- IEC 61158-2 (MBP)

*PROFIBUS DP*

The IEC 61158 standard specifies two types of cable (A and B) for the bus line which can be used for every transmission rate. Cable type A is recommended.

<b>Cable type</b>	A
<b>Characteristic impedance</b>	135 to 165 Ω at a measuring frequency of 3 to 20 MHz
<b>Cable capacitance</b>	< 30 pF/m
<b>Wire cross-section</b>	> 0.34 mm <sup>2</sup> (22 AWG)
<b>Cable type</b>	Twisted pairs
<b>Loop resistance</b>	≤110 Ω/km
<b>Signal damping</b>	Max. 9 dB over the entire length of the cable cross-section
<b>Shield</b>	Copper braided shielding or braided shielding with foil shield. When grounding the cable shield, observe the grounding concept of the plant.



For further information on planning and installing PROFIBUS networks see:

- Operating Instructions "PROFIBUS DP/PA: Guidelines for planning and commissioning" (BA00034S)
- PNO Directive 2.092 "PROFIBUS PA User and Installation Guideline"
- IEC 61158-2 (MBP)

*EtherNet/IP*

The standard ANSI/TIA/EIA-568-B.2 Annex specifies CAT 5 as the minimum category for a cable used for EtherNet/IP. CAT 5e and CAT 6 are recommended.



For more information on planning and installing EtherNet/IP networks, please refer to the "Media Planning and Installation Manual. EtherNet/IP" of ODVA Organization

*PROFINET*

Standard IEC 61156-6 specifies CAT 5 as the minimum category for a cable used for PROFINET. CAT 5e and CAT 6 are recommended.



For more information on planning and installing PROFINET networks, see: "PROFINET Cabling and Interconnection Technology", Guideline for PROFINET

*FOUNDATION Fieldbus*

Twisted, shielded two-wire cable.



For further information on planning and installing FOUNDATION Fieldbus networks see:

- Operating Instructions for "FOUNDATION Fieldbus Overview" (BA00013S)
- FOUNDATION Fieldbus Guideline
- IEC 61158-2 (MBP)

*Modbus RS485*

The EIA/TIA-485 standard specifies two types of cable (A and B) for the bus line which can be used for every transmission rate. Cable type A is recommended.

<b>Cable type</b>	A
<b>Characteristic impedance</b>	135 to 165 $\Omega$ at a measuring frequency of 3 to 20 MHz
<b>Cable capacitance</b>	< 30 pF/m
<b>Wire cross-section</b>	> 0.34 mm <sup>2</sup> (22 AWG)
<b>Cable type</b>	Twisted pairs
<b>Loop resistance</b>	$\leq$ 110 $\Omega$ /km
<b>Signal damping</b>	Max. 9 dB over the entire length of the cable cross-section
<b>Shield</b>	Copper braided shielding or braided shielding with foil shield. When grounding the cable shield, observe the grounding concept of the plant.

*Current output 0/4 to 20 mA*

Standard installation cable is sufficient.

*Pulse/frequency/switch output*

Standard installation cable is sufficient.

*Double pulse output*

Standard installation cable is sufficient.

*Relay output*

Standard installation cable is sufficient.

*Current input 0/4 to 20 mA*

Standard installation cable is sufficient.

*Status input*

Standard installation cable is sufficient.

**Connecting cable for transmitter - remote display and operating module DKX001***Standard cable*

A standard cable can be used as the connecting cable.

<b>Standard cable</b>	4 cores (2 pairs); pair-stranded with common shield
<b>Shielding</b>	Tin-plated copper-braid, optical cover $\geq$ 85 %
<b>Capacitance: core/shield</b>	Maximum 1 000 nF for Zone 1; Class I, Division 1
<b>L/R</b>	Maximum 24 $\mu$ H/ $\Omega$ for Zone 1; Class I, Division 1
<b>Cable length</b>	Maximum 300 m (1 000 ft), see the following table

<b>Cross-section</b>	<b>Cable length for use in:</b> <ul style="list-style-type: none"> <li>▪ Non-hazardous area</li> <li>▪ Hazardous area: Zone 2; Class I, Division 2</li> <li>▪ Hazardous area: Zone 1; Class I, Division 1</li> </ul>
0.34 mm <sup>2</sup> (22 AWG)	80 m (270 ft)
0.50 mm <sup>2</sup> (20 AWG)	120 m (400 ft)
0.75 mm <sup>2</sup> (18 AWG)	180 m (600 ft)



Cross-section	Cable length for use in: <ul style="list-style-type: none"> <li>Non-hazardous area</li> <li>Hazardous area: Zone 2; Class I, Division 2</li> <li>Hazardous area: Zone 1; Class I, Division 1</li> </ul>
1.00 mm <sup>2</sup> (17 AWG)	240 m (800 ft)
1.50 mm <sup>2</sup> (15 AWG)	300 m (1000 ft)

*Optionally available connecting cable*



Standard cable	2 × 2 × 0.34 mm <sup>2</sup> (22 AWG) PVC cable <sup>1)</sup> with common shield (2 pairs, pair-stranded)
Flame resistance	According to DIN EN 60332-1-2
Oil-resistance	According to DIN EN 60811-2-1
Shielding	Tin-plated copper-braid, optical cover ≥ 85 %
Capacitance: core/shield	≤200 pF/m
L/R	≤24 μH/Ω
Available cable length	10 m (35 ft)
Operating temperature	When mounted in a fixed position: -50 to +105 °C (-58 to +221 °F); when cable can move freely: -25 to +105 °C (-13 to +221 °F)

1) UV radiation can impair the cable outer sheath. Protect the cable from direct sunshine where possible.

## Performance characteristics

**Reference operating conditions**

- Error limits based on ISO 11631
- Water with +15 to +45 °C (+59 to +113 °F) at 2 to 6 bar (29 to 87 psi)
- Specifications as per calibration protocol
- Accuracy based on accredited calibration rigs that are traced to ISO 17025.

 To obtain measured errors, use the *Applicator* sizing tool →  98

**Maximum measured error**

o.r. = of reading; 1 g/cm<sup>3</sup> = 1 kg/l; T = medium temperature

**Base accuracy**

 Design fundamentals →  48

*Mass flow and volume flow (liquids)*

±0.10 % o.r.

*Density (liquids)*

Under reference operating conditions [g/cm <sup>3</sup> ]	Standard density calibration <sup>1)</sup> [g/cm <sup>3</sup> ]	Wide-range Density specification <sup>2) 3)</sup> [g/cm <sup>3</sup> ]
±0.0005	±0.01	±0.002

- 1) Valid over the entire temperature and density range
- 2) Valid range for special density calibration: 0 to 2 g/cm<sup>3</sup>, +10 to +80 °C (+50 to +176 °F)
- 3) Order code for "Application package", option EE "Special density"

*Temperature*

$$\pm 0.5\text{ }^{\circ}\text{C} \pm 0.005 \cdot T\text{ }^{\circ}\text{C} (\pm 0.9\text{ }^{\circ}\text{F} \pm 0.003 \cdot (T - 32)\text{ }^{\circ}\text{F})$$

**Zero point stability**

DN		Zero point stability	
[mm]	[in]	[kg/h]	[lb/min]
8	$\frac{3}{8}$	0.20	0.007
15	$\frac{1}{2}$	0.65	0.024
25	1	1.80	0.066
40	$1\frac{1}{2}$	4.50	0.165
50	2	7.0	0.257

**Flow values**

Flow values as turndown parameter depending on nominal diameter.

*SI units*

DN	1:1	1:10	1:20	1:50	1:100	1:500
[mm]	[kg/h]	[kg/h]	[kg/h]	[kg/h]	[kg/h]	[kg/h]
8	2 000	200	100	40	20	4
15	6 500	650	325	130	65	13
25	18 000	1 800	900	360	180	36
40	45 000	4 500	2 250	900	450	90
50	70 000	7 000	3 500	1 400	700	140

*US units*

DN	1:1	1:10	1:20	1:50	1:100	1:500
[inch]	[lb/min]	[lb/min]	[lb/min]	[lb/min]	[lb/min]	[lb/min]
$\frac{3}{8}$	73.50	7.350	3.675	1.470	0.735	0.147
$\frac{1}{2}$	238.9	23.89	11.95	4.778	2.389	0.478
1	661.5	66.15	33.08	13.23	6.615	1.323
$1\frac{1}{2}$	1 654	165.4	82.70	33.08	16.54	3.308
2	2 573	257.3	128.7	51.46	25.73	5.146

**Accuracy of outputs**

The outputs have the following base accuracy specifications.

*Current output*

<b>Accuracy</b>	$\pm 5\text{ }\mu\text{A}$
-----------------	----------------------------

*Pulse/frequency output*

o.r. = of reading

<b>Accuracy</b>	Max. $\pm 50\text{ ppm}$ o.r. (over the entire ambient temperature range)
-----------------	---

**Repeatability**

o.r. = of reading;  $1 \text{ g/cm}^3 = 1 \text{ kg/l}$ ; T = medium temperature

**Base repeatability**

 Design fundamentals →  48

*Mass flow and volume flow (liquids)*

$\pm 0.05 \%$  o.r.

*Density (liquids)*

$\pm 0.00025 \text{ g/cm}^3$

*Temperature*

$\pm 0.25 \text{ }^\circ\text{C} \pm 0.0025 \cdot T \text{ }^\circ\text{C}$  ( $\pm 0.45 \text{ }^\circ\text{F} \pm 0.0015 \cdot (T-32) \text{ }^\circ\text{F}$ )

**Response time**

The response time depends on the configuration (damping).

**Influence of ambient temperature**

**Current output**

<b>Temperature coefficient</b>	Max. $1 \mu\text{A}/^\circ\text{C}$
--------------------------------	-------------------------------------

**Pulse/frequency output**

<b>Temperature coefficient</b>	No additional effect. Included in accuracy.
--------------------------------	---

**Influence of medium temperature**

**Mass flow and volume flow**

o.f.s. = of full scale value

When there is a difference between the temperature for zero point adjustment and the process temperature, the additional measured error of the sensor is typically  $\pm 0.0002 \%$  o.f.s./ $^\circ\text{C}$  ( $\pm 0.0001 \%$  o. f.s./ $^\circ\text{F}$ ).

The effect is reduced if zero point adjustment is performed at process temperature.

**Density**

When there is a difference between the density calibration temperature and the process temperature, the typical measured error of the sensor is  $\pm 0.0001 \text{ g/cm}^3 / ^\circ\text{C}$  ( $\pm 0.00005 \text{ g/cm}^3 / ^\circ\text{F}$ ). Field density calibration is possible.

**Wide-range density specification (special density calibration)**

If the process temperature is outside the valid range (→  45) the measured error is  $\pm 0.0001 \text{ g/cm}^3 / ^\circ\text{C}$  ( $\pm 0.00005 \text{ g/cm}^3 / ^\circ\text{F}$ )

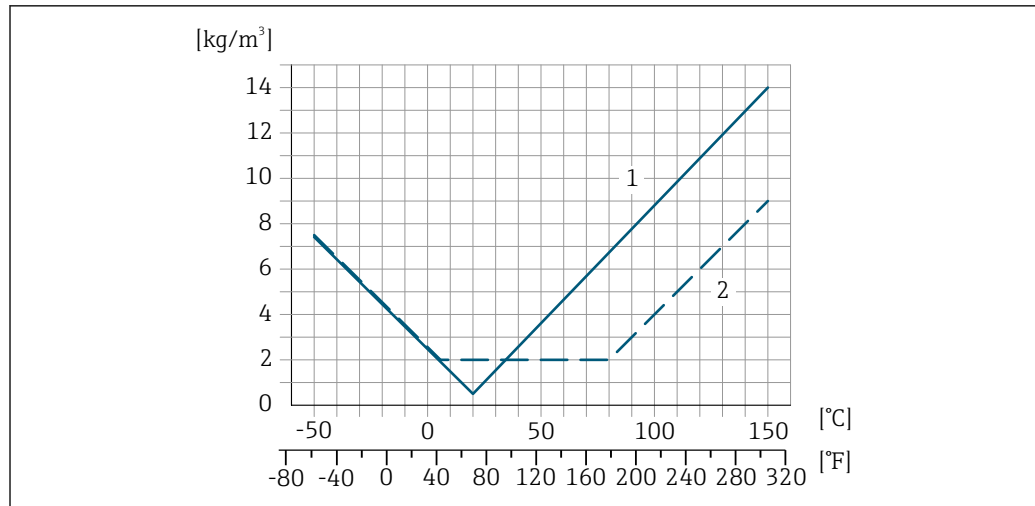

A0016611

- 1 Field density calibration, for example at +20 °C (+68 °F)
- 2 Special density calibration

**Temperature**

$\pm 0.005 \cdot T \text{ } ^\circ\text{C}$  ( $\pm 0.005 \cdot (T - 32) \text{ } ^\circ\text{F}$ )

**Influence of medium pressure**

The table below shows the effect on accuracy of mass flow due to a difference between calibration pressure and process pressure.

o.r. = of reading



It is possible to compensate for the effect by:

- Reading in the current pressure measured value via the current input.
- Specifying a fixed value for the pressure in the device parameters.



Operating Instructions → 100.

DN		[% o.r./bar]	[% o.r./psi]
[mm]	[in]		
8	3/8	-0.002	-0.0001
15	1/2	-0.006	-0.0004
25	1	-0.005	-0.0003
40	1 1/2	-0.007	-0.0005
50	2	-0.006	-0.0004

**Design fundamentals**

o.r. = of reading, o.f.s. = of full scale value

BaseAccu = base accuracy in % o.r., BaseRepeat = base repeatability in % o.r.

MeasValue = measured value; ZeroPoint = zero point stability

Calculation of the maximum measured error as a function of the flow rate

Flow rate	Maximum measured error in % o.r.
$\geq \frac{\text{ZeroPoint}}{\text{BaseAccu}} \cdot 100$ <small>A0021332</small>	$\pm \text{BaseAccu}$ <small>A0021339</small>
$< \frac{\text{ZeroPoint}}{\text{BaseAccu}} \cdot 100$ <small>A0021333</small>	$\pm \frac{\text{ZeroPoint}}{\text{MeasValue}} \cdot 100$ <small>A0021334</small>

Calculation of the maximum repeatability as a function of the flow rate

Flow rate	Maximum repeatability in % o.r.
$\geq \frac{1/2 \cdot \text{ZeroPoint}}{\text{BaseRepeat}} \cdot 100$ <small>A0021335</small>	$\pm \text{BaseRepeat}$ <small>A0021340</small>
$< \frac{1/2 \cdot \text{ZeroPoint}}{\text{BaseRepeat}} \cdot 100$ <small>A0021336</small>	$\pm 1/2 \cdot \frac{\text{ZeroPoint}}{\text{MeasValue}} \cdot 100$ <small>A0021337</small>

Example for maximum measured error

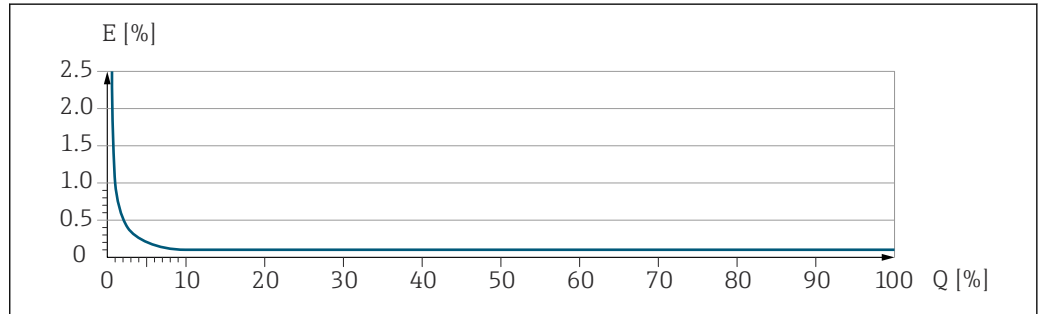

E Maximum measured error in % o.r. (example)  
 Q Flow rate in % of maximum full scale value

Installation

No special measures such as supports etc. are necessary. External forces are absorbed by the construction of the device.

Mounting location

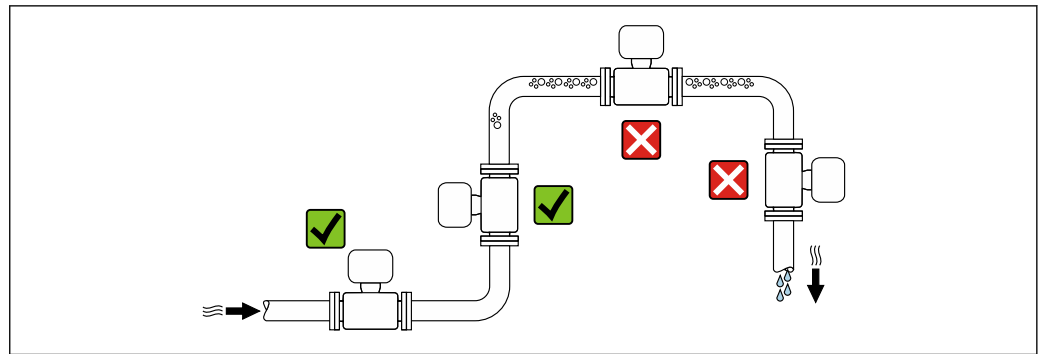

To prevent measuring errors arising from accumulation of gas bubbles in the measuring tube, avoid the following mounting locations in the pipe:

- Highest point of a pipeline.
- Directly upstream of a free pipe outlet in a down pipe.

Installation in down pipes

However, the following installation suggestion allows for installation in an open vertical pipeline. Pipe restrictions or the use of an orifice with a smaller cross-section than the nominal diameter prevent the sensor running empty while measurement is in progress.

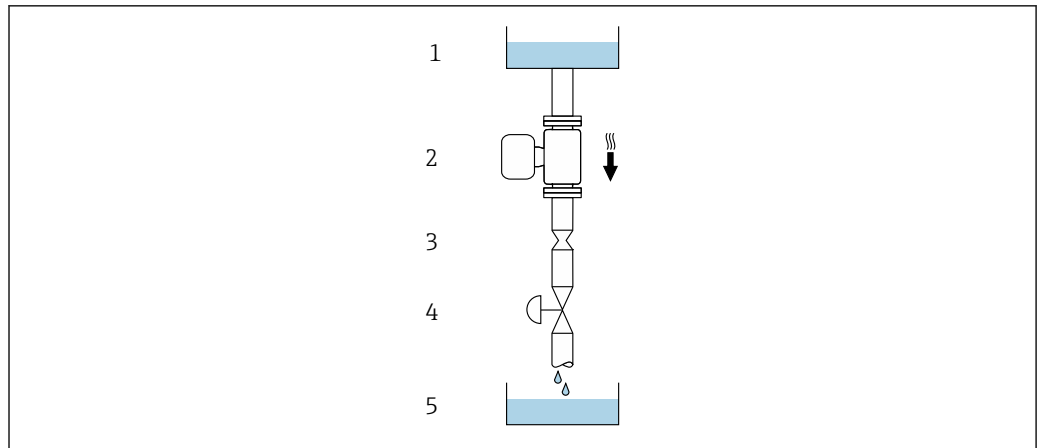

A0028773

21 Installation in a down pipe (e.g. for batching applications)

- 1 Supply tank
- 2 Sensor
- 3 Orifice plate, pipe restriction
- 4 Valve
- 5 Batching tank

DN		Ø orifice plate, pipe restriction	
[mm]	[in]	[mm]	[in]
8	3/8	6	0.24
15	1/2	10	0.40
25	1	14	0.55
40	1 1/2	22	0.87
50	2	28	1.10

**Orientation**

The direction of the arrow on the sensor nameplate helps you to install the sensor according to the flow direction (direction of medium flow through the piping).

Orientation		Recommendation	
<b>A</b>	Vertical orientation	 <small>A0015591</small>	<input checked="" type="checkbox"/> <input checked="" type="checkbox"/> <sup>1)</sup>
<b>B</b>	Horizontal orientation, transmitter at top	 <small>A0015589</small>	<input checked="" type="checkbox"/> <input checked="" type="checkbox"/> <sup>2)</sup> Exceptions: →  22,  51
<b>C</b>	Horizontal orientation, transmitter at bottom	 <small>A0015590</small>	<input checked="" type="checkbox"/> <input checked="" type="checkbox"/> <sup>3)</sup> Exceptions: →  22,  51
<b>D</b>	Horizontal orientation, transmitter at side	 <small>A0015592</small>	<input checked="" type="checkbox"/> <input checked="" type="checkbox"/>

- 1) This orientation is recommended to ensure self-draining.
- 2) Applications with low process temperatures may decrease the ambient temperature. To maintain the minimum ambient temperature for the transmitter, this orientation is recommended.
- 3) Applications with high process temperatures may increase the ambient temperature. To maintain the maximum ambient temperature for the transmitter, this orientation is recommended.

If a sensor is installed horizontally with a curved measuring tube, match the position of the sensor to the fluid properties.

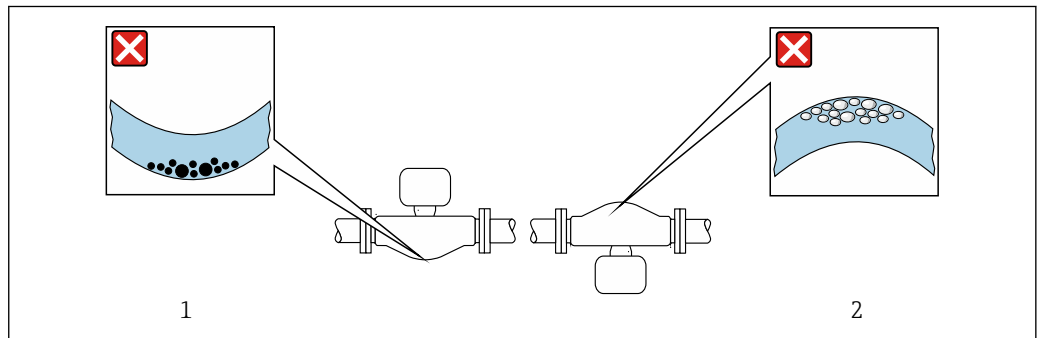

22 Orientation of sensor with curved measuring tube

- 1 Avoid this orientation for fluids with entrained solids: Risk of solids accumulating.
- 2 Avoid this orientation for outgassing fluids: Risk of gas accumulating.

**Inlet and outlet runs**

No special precautions need to be taken for fittings which create turbulence, such as valves, elbows or T-pieces, as long as no cavitation occurs → 58.

**Special mounting instructions**

**Drainability**

The measuring tubes can be completely drained and protected against solids build-up in vertical orientation.

**Sanitary compatibility**

**i** When installing in hygienic applications, please refer to the information in the "Certificates and approvals/hygienic compatibility" section → 92.

**Securing with mounting clamp in the case of hygiene connections**

It is not necessary to provide additional support for the sensor for operational performance purposes. If, however, additional support is required for installation purposes, the following dimensions must be observed.

Use mounting clamp with lining between clamp and measuring instrument.

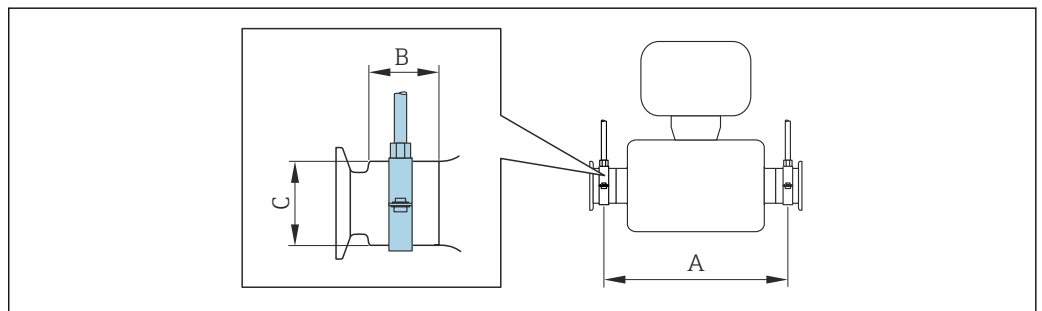

DN		A		B		C	
[mm]	[in]	[mm]	[in]	[mm]	[in]	[mm]	[in]
8	3/8	298	11.73	33	1.3	28	1.1
15	1/2	402	15.83	33	1.3	28	1.1
25	1	542	21.34	33	1.3	38	1.5
40	1 1/2	658	25.91	36.5	1.44	56	2.2
50	2	772	30.39	44.1	1.74	75	2.95

### Zero point adjustment

All measuring devices are calibrated in accordance with state-of-the-art technology. Calibration takes place under reference conditions →  45. Therefore, a zero point adjustment in the field is generally not required.

Experience shows that zero point adjustment is advisable only in special cases:

- To achieve maximum measuring accuracy even with low flow rates.
- Under extreme process or operating conditions (e.g. very high process temperatures or very high-viscosity fluids).

### Protective cover

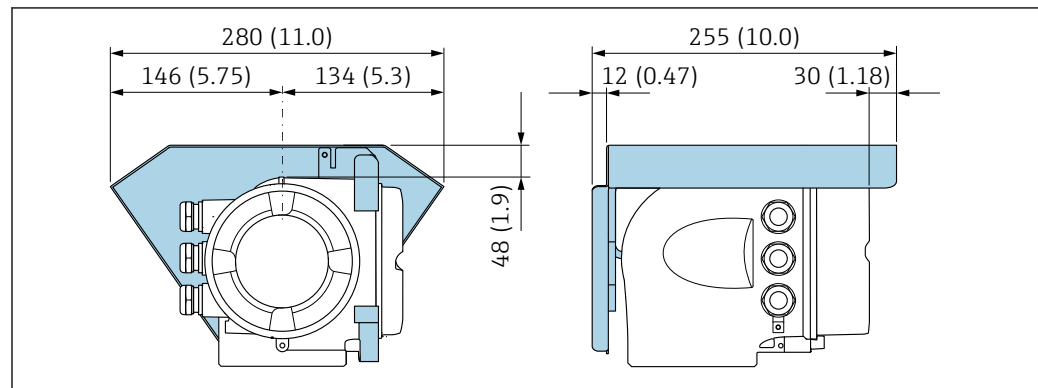



## Environment

### Ambient temperature range

<b>Measuring device</b>	<ul style="list-style-type: none"> <li>▪ -40 to +60 °C (-40 to +140 °F)</li> <li>▪ Order code for "Test, certificate", option JP: -50 to +60 °C (-58 to +140 °F)</li> </ul>
<b>Readability of the local display</b>	-20 to +60 °C (-4 to +140 °F) The readability of the display may be impaired at temperatures outside the temperature range.

 Dependency of ambient temperature on medium temperature →  53

- ▶ If operating outdoors:  
Avoid direct sunlight, particularly in warm climatic regions.

 You can order a weather protection cover from Endress+Hauser. →  96.

### Storage temperature

-50 to +80 °C (-58 to +176 °F)

### Climate class

DIN EN 60068-2-38 (test Z/AD)

### Degree of protection

#### Measuring device

- As standard: IP66/67, type 4X enclosure
- When housing is open: IP20, type 1 enclosure
- Display module: IP20, type 1 enclosure
- With the order code for "Sensor options", option CM: IP69 can also be ordered

#### External WLAN antenna

IP67

### Vibration- and shock-resistance

Vibration broad-band random, according to IEC 60068-2-6



- 2 to 8.4 Hz, 3.5 mm peak
- 8.4 to 2 000 Hz, 1 g peak

**Vibration broad-band random, according to IEC 60068-2-64**

- 10 to 200 Hz, 0.003 g<sup>2</sup>/Hz
- 200 to 2 000 Hz, 0.001 g<sup>2</sup>/Hz
- Total: 1.54 g rms

**Shock half-sine, according to IEC 60068-2-27**

6 ms 30 g

**Rough handling shocks, according to IEC 60068-2-31**

---

**Interior cleaning**

- Cleaning in place (CIP)
- Sterilization in place (SIP)
- Cleaning with pigs

**Options**

Oil- and grease-free version for wetted parts, without declaration  
Order code for "Service", option HA

---

**Electromagnetic compatibility (EMC)**

- As per IEC/EN 61326 and NAMUR Recommendation 21 (NE 21)
- Device version with PROFIBUS DP: Complies with emission limits for industry as per EN 50170 Volume 2, IEC 61784



The following applies for PROFIBUS DP: If baud rates > 1.5 Mbaud, an EMC cable entry must be used and the cable shield must continue as far as the terminal wherever possible.



Details are provided in the Declaration of Conformity.

## Process

---

**Medium temperature range**    -50 to +150 °C (-58 to +302 °F)

Dependency of ambient temperature on medium temperature

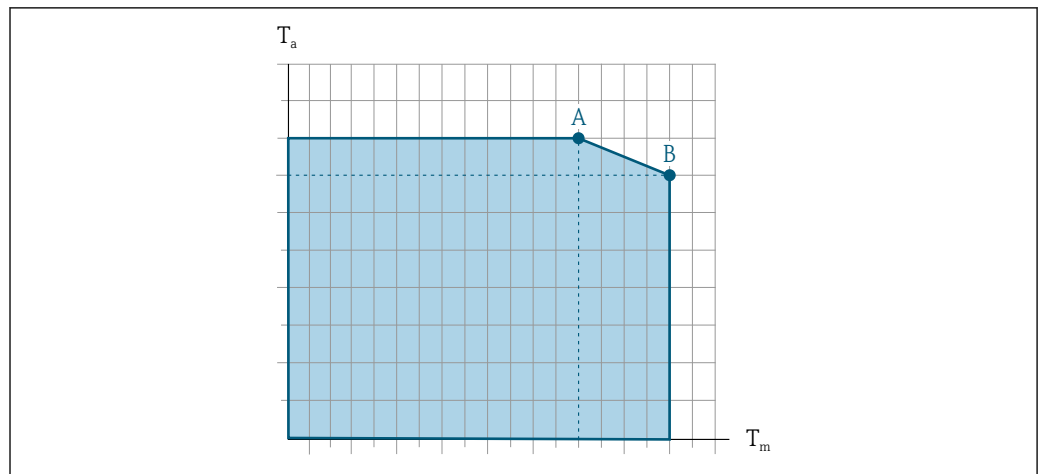

A0031121

23 Exemplary representation, values in the table below.

$T_a$  Ambient temperature range

$T_m$  Medium temperature

A Maximum permitted medium temperature  $T_m$  at  $T_{a\ max} = 60\text{ °C (140 °F)}$ ; higher medium temperatures  $T_m$  require a reduced ambient temperature  $T_a$

B Maximum permitted ambient temperature  $T_a$  for the maximum specified medium temperature  $T_m$  of the sensor

**i** Values for devices used in the hazardous area:  
Separate Ex documentation (XA) for the device → 100.

Not insulated				Insulated			
A		B		A		B	
$T_a$	$T_m$	$T_a$	$T_m$	$T_a$	$T_m$	$T_a$	$T_m$
60 °C (140 °F)	150 °C (302 °F)	-	-	60 °C (140 °F)	120 °C (248 °F)	55 °C (131 °F)	150 °C (302 °F)

Density 0 to 5 000 kg/m<sup>3</sup> (0 to 312 lb/cf)

Pressure-temperature ratings

The following pressure/temperature diagrams apply to all pressure-bearing parts of the device and not just the process connection. The diagrams show the maximum permissible medium pressure depending on the specific medium temperature.

Flange according to EN 1092-1 (DIN 2501)

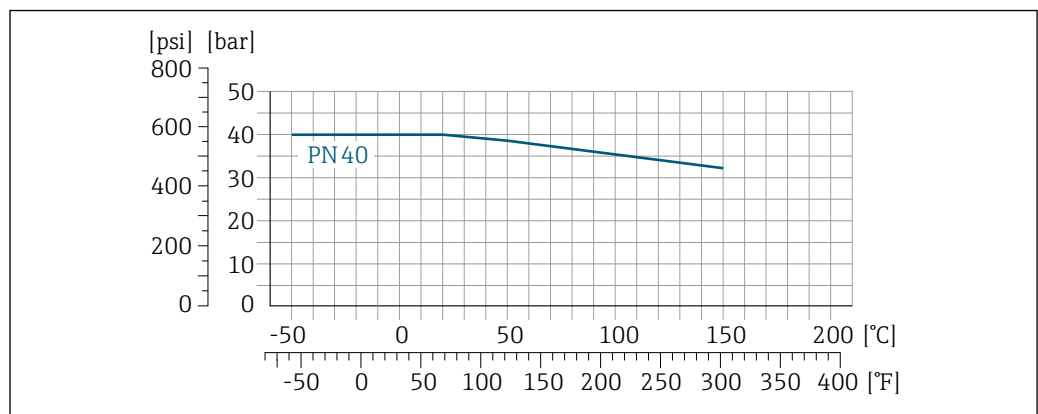

A0029905-EN

24 With flange material 1.4404 (F316/F316L)

**Flange according to ASME B16.5**

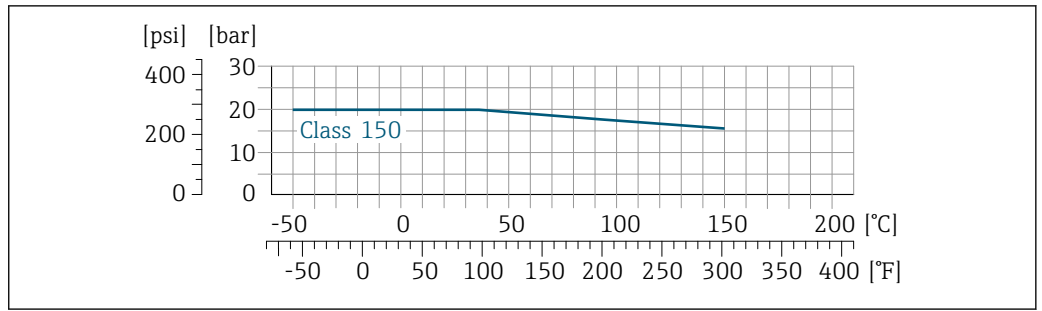

A0029906-EN

25 With flange material 1.4404 (F316/F316L)

**Flange JIS B2220**

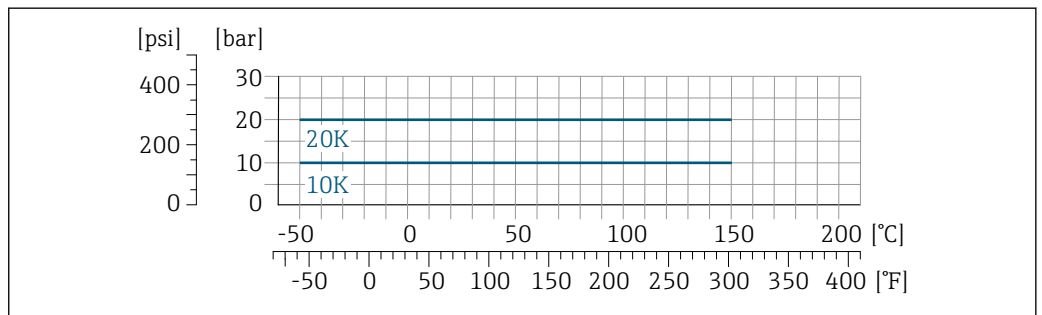

A0029907-EN

26 With flange material 1.4404 (F316/F316L)

**Flange DIN 11864-2 Form A**

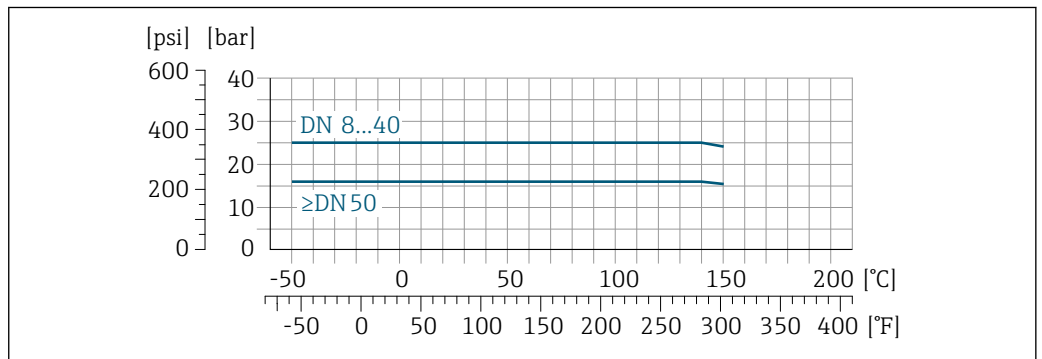

A0029908-EN

27 With flange material 1.4435 (316L)

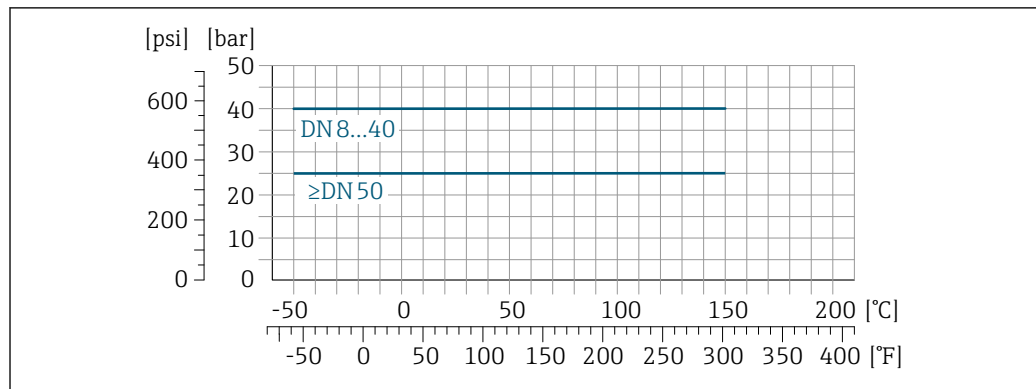
**Thread DIN 11851**

A0029909-EN

28 With flange material 1.4435 (316L)

DIN 11851 allows for applications up to +140 °C (+284 °F) if suitable sealing materials are used. Please take this into account when selecting seals and counterparts, as these components can limit the pressure and temperature range.

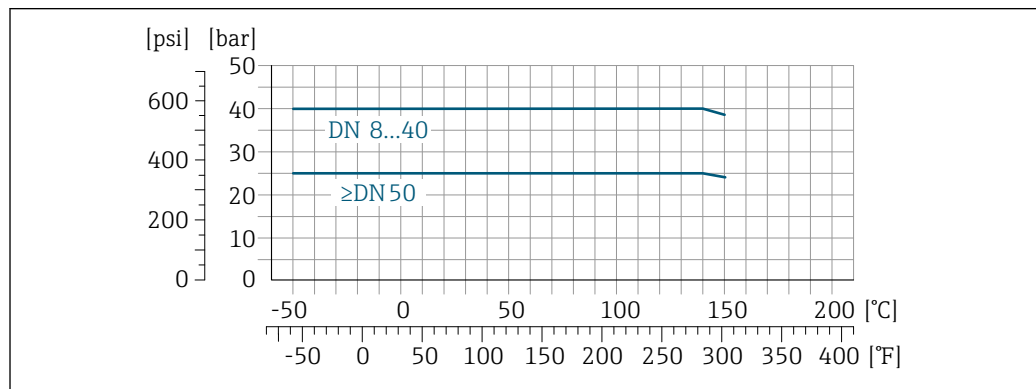
**Thread DIN 11864-1 Form A**

A0029910-EN

29 With connection material 1.4435 (316L)

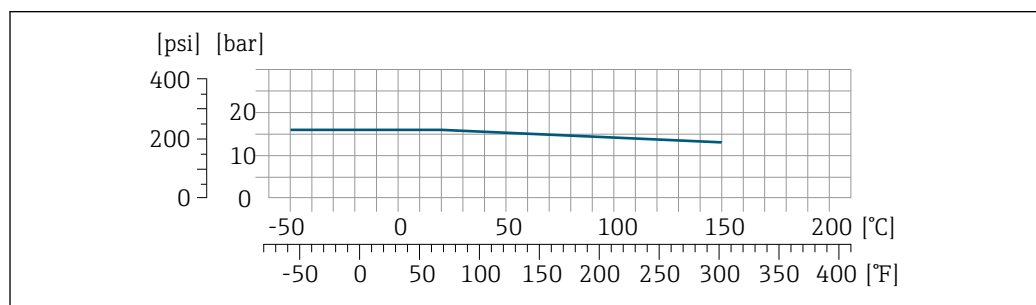
**Thread ISO 2853**

A0034703-EN

30 With connection material 1.4435 (316L)

**Thread SMS 1145**

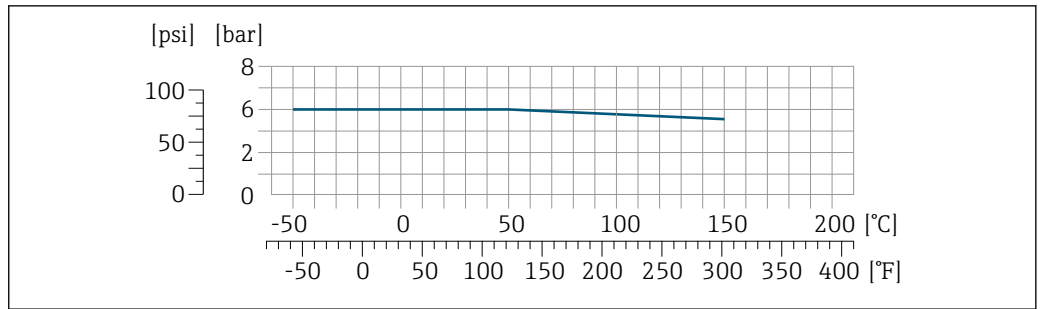

A0029889-EN

31 With connection material 1.4435 (316L)

SMS 1145 allows for applications up to 6 bar (87 psi) if suitable sealing materials are used. Please take this into account when selecting seals and counterparts, as these components can limit the pressure and temperature range.

**Clamp connections DIN 11864-3 Form A**

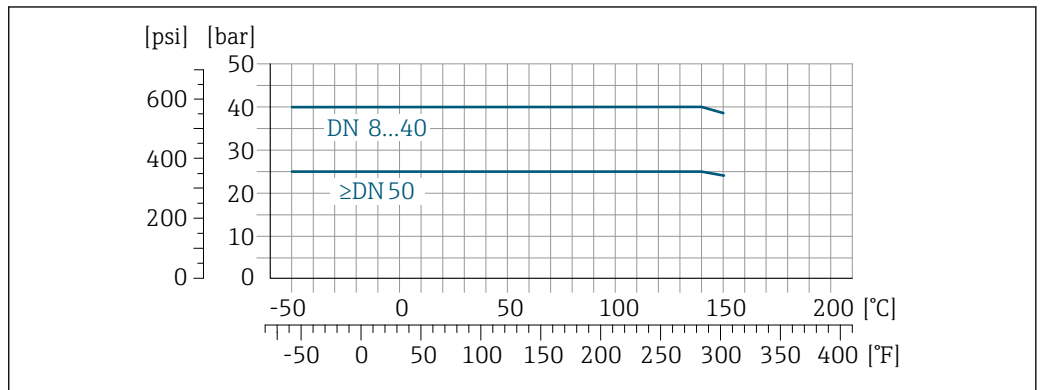

A0029910-EN

32 With connection material 1.4435 (316L)

**Tri-Clamp**

The clamp connections are suitable up to a maximum pressure of 16 bar (232 psi). Please observe the operating limits of the clamp and seal used as they can be over 16 bar (232 psi). The clamp and seal are not included in the scope of supply.

**Sensor housing**

The sensor housing is filled with dry nitrogen gas and protects the electronics and mechanics inside.

**i** If a measuring tube fails (e.g. due to process characteristics like corrosive or abrasive fluids), the fluid will initially be contained by the sensor housing.

If the sensor is to be purged with gas (gas detection), it should be equipped with purge connections.

**i** Do not open the purge connections unless the containment can be filled immediately with a dry, inert gas. Use only low pressure to purge.

Maximum pressure: 5 bar (72.5 psi)

**Burst pressure of the sensor housing**

The following sensor housing burst pressures are only valid for standard devices and/or devices equipped with closed purge connections (not opened/as delivered).

If a device fitted with purge connections (order code for "Sensor option", option CH "Purge connection") is connected to the purge system, the maximum pressure is determined by the purge system itself or by the device, depending on which component has the lower pressure classification.



The sensor housing burst pressure refers to a typical internal pressure which is reached prior to mechanical failure of the sensor housing and which was determined during type testing. The corresponding type test declaration can be ordered with the device (order code for "Additional approval", option LN "Sensor housing burst pressure, type test").

DN		Sensor housing burst pressure	
[mm]	[in]	[bar]	[psi]
8	$\frac{3}{8}$	190	2755
15	$\frac{1}{2}$	175	2538
25	1	165	2392
40	$1\frac{1}{2}$	152	2204
50	2	103	1494

For information on the dimensions: see the "Mechanical construction" section →  60

### Flow limit



Select the nominal diameter by optimizing between the required flow range and permissible pressure loss.

 For an overview of the full scale values for the measuring range, see the "Measuring range" section →  10

- The minimum recommended full scale value is approx. 1/20 of the maximum full scale value
- In most applications, 20 to 50 % of the maximum full scale value can be considered ideal
- A low full scale value must be selected for abrasive media (such as liquids with entrained solids): flow velocity < 1 m/s (< 3 ft/s).

 To calculate the flow limit, use the *Applicator* sizing tool →  98

### Pressure loss

 To calculate the pressure loss, use the *Applicator* sizing tool →  98

### System pressure

It is important that cavitation does not occur, or that gases entrained in the liquids do not outgas. This is prevented by means of a sufficiently high system pressure.

For this reason, the following mounting locations are recommended:

- At the lowest point in a vertical pipe
- Downstream from pumps (no danger of vacuum)

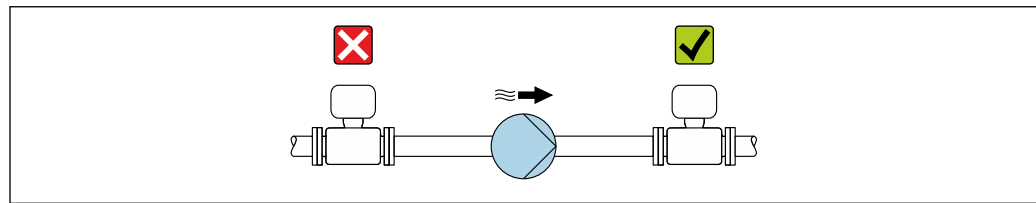

A0028777

### Thermal insulation

In the case of some fluids, it is important to keep the heat radiated from the sensor to the transmitter to a low level. A wide range of materials can be used for the required insulation.

The following device versions are recommended for versions with thermal insulation:

Version with extended neck for insulation:

Order code for "Sensor option", option CG with an extended neck length of 105 mm (4.13 in).

#### NOTICE

##### Electronics overheating on account of thermal insulation!

- ▶ Recommended orientation: horizontal orientation, transmitter housing pointing downwards.
- ▶ Do not insulate the transmitter housing .
- ▶ Maximum permissible temperature at the lower end of the transmitter housing: 80 °C (176 °F)
- ▶ Thermal insulation with extended neck free: We recommend that you do not insulate the extended neck in order to ensure optimum dissipation of heat.

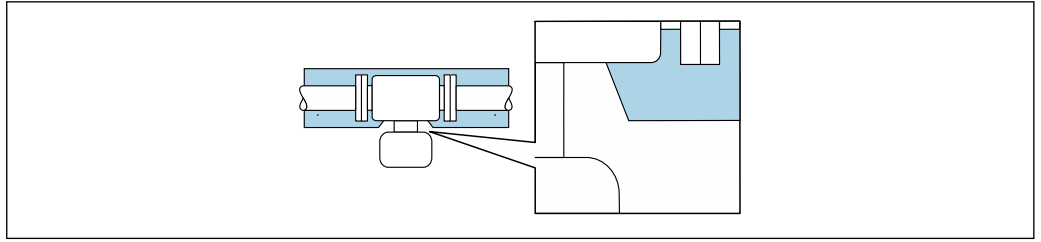

33 Thermal insulation with extended neck free

A0034391

## Heating

Some fluids require suitable measures to avoid loss of heat at the sensor.

### Heating options

- Electrical heating, e.g. with electric band heaters
- Via pipes carrying hot water or steam
- Via heating jackets



Heating jackets for the sensors can be ordered as accessories from Endress+Hauser. → 97

### NOTICE

#### Danger of overheating when heating

- ▶ Ensure that the temperature at the lower end of the transmitter housing does not exceed 80 °C (176 °F).
- ▶ Ensure that sufficient convection takes place at the transmitter neck.
- ▶ Ensure that a sufficiently large area of the transmitter neck remains exposed. The uncovered part serves as a radiator and protects the electronics from overheating and excessive cooling.
- ▶ When using in potentially explosive atmospheres, observe the information in the device-specific Ex documentation. For detailed information on the temperature tables, see the separate document entitled "Safety Instructions" (XA) for the device.

## Vibrations

The high oscillation frequency of the measuring tubes ensures that the correct operation of the measuring system is not influenced by plant vibrations.

## Mechanical construction

Dimensions in SI units

Compact version

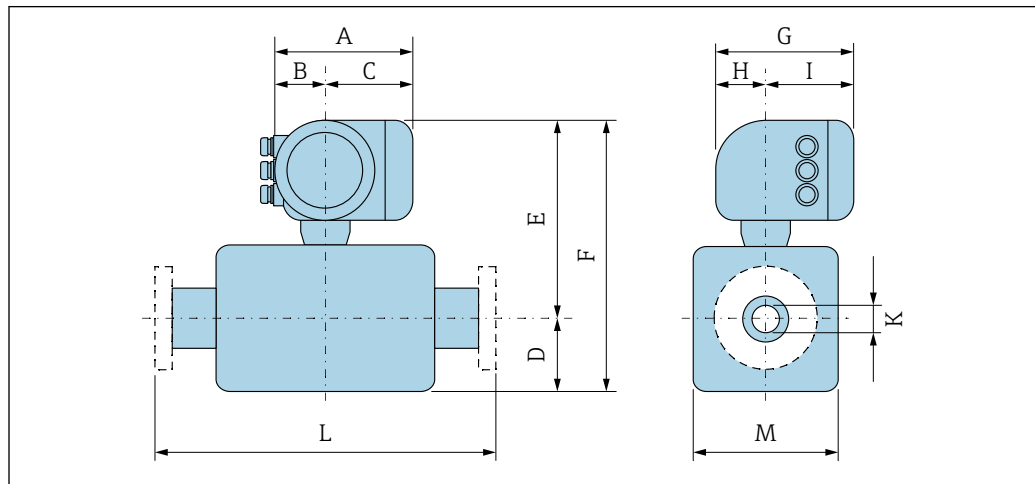

A0039785

Order code for "Housing", option A "Aluminum, coated"

DN	A <sup>1)</sup>	B <sup>1)</sup>	C	D	E <sup>2)</sup>	F <sup>2)</sup>	G <sup>3)</sup>	H	I <sup>3)</sup>	K	L	M
[mm]	[mm]	[mm]	[mm]	[mm]	[mm]	[mm]	[mm]	[mm]	[mm]	[mm]	[mm]	[mm]
8	169	68	101	108	266	374	200	59	141	8.30	<sup>4)</sup>	92
15	169	68	101	108	266	374	200	59	141	12.0	<sup>4)</sup>	92
25	169	68	101	121	266	387	200	59	141	17.6	<sup>4)</sup>	92
40	169	68	101	178	297	475	200	59	141	26.0	<sup>4)</sup>	142
50	169	68	101	262	310	572	200	59	141	38.0	<sup>4)</sup>	169

- 1) Depending on the cable gland used: values up to + 30 mm
- 2) With order code for "Sensor option", option CG: values +70 mm
- 3) For version without local display: values - 30 mm
- 4) Depends on the process connection in question

Order code for "Housing", option A "Aluminum, coated"; Ex d

DN	A <sup>1)</sup>	B	C	D	E <sup>2)</sup>	F <sup>2)</sup>	G <sup>3)</sup>	H	I <sup>3)</sup>	K	L	M
[mm]	[mm]	[mm]	[mm]	[mm]	[mm]	[mm]	[mm]	[mm]	[mm]	[mm]	[mm]	[mm]
8	188	85	103	108	278	404	217	58	148	8.30	<sup>4)</sup>	92
15	188	85	103	108	278	404	217	58	148	12.0	<sup>4)</sup>	92
25	188	85	103	121	278	417	217	58	148	17.6	<sup>4)</sup>	92
40	188	85	103	178	308	505	217	58	148	26.0	<sup>4)</sup>	142
50	188	85	103	262	322	602	217	58	148	38.0	<sup>4)</sup>	169

- 1) Depending on the cable gland used: values up to + 30 mm
- 2) With order code for "Sensor option", option CG: values +70 mm
- 3) For version without local display: values - 49 mm
- 4) Depends on the process connection in question



Order code for "Housing", option B "Stainless, hygienic"

DN	A <sup>1)</sup>	B	C	D	E <sup>2)</sup>	F <sup>2)</sup>	G	H	I	K	L	M
[mm]	[mm]	[mm]	[mm]	[mm]	[mm]	[mm]	[mm]	[mm]	[mm]	[mm]	[mm]	[mm]
8	183	73	110	108	266	374	207	65	142	8.30	<sup>3)</sup>	92
15	183	73	110	108	266	374	207	65	142	12.0	<sup>3)</sup>	92
25	183	73	110	121	266	387	207	65	142	17.6	<sup>3)</sup>	92
40	183	73	110	178	297	475	207	65	142	26.0	<sup>3)</sup>	142
50	183	73	110	262	310	572	207	65	142	38.0	<sup>3)</sup>	169

- 1) Depending on the cable gland used: values up to + 30 mm
- 2) With order code for "Sensor option", option CG: values +70 mm
- 3) Depends on the process connection in question

**Flange connections**

Fixed flange EN 1092-1, ASME B16.5, JIS B2220

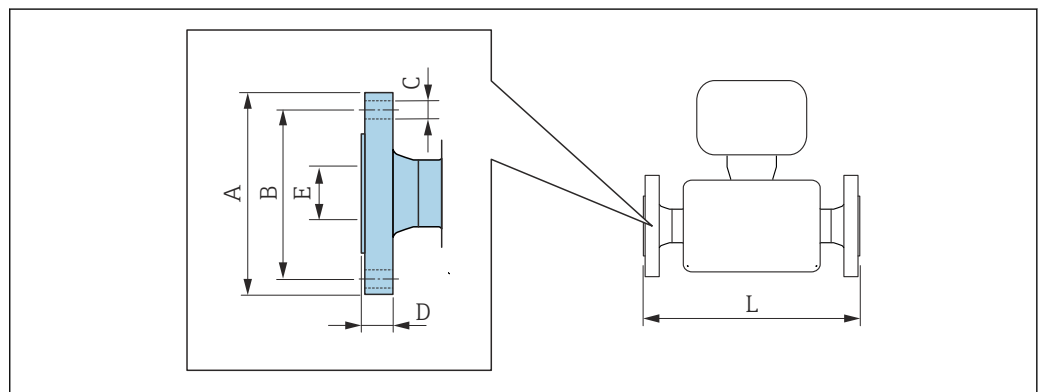

A0015621

**i** Length tolerance for dimension L in mm:  
+1.5 / -2.0

Flange according to EN 1092-1 (DIN 2501): PN 40 1.4404 (F316/F316L)						
Order code for "Process connection", option D2W						
DN [mm]	A [mm]	B [mm]	C [mm]	D [mm]	E [mm]	L [mm]
8 <sup>1)</sup>	95	65	4 × Ø14	17.0	17.3	336
15	95	65	4 × Ø14	20	17.3	440
25	115	85	4 × Ø14	19.0	28.5	580
40	150	110	4 × Ø18	21.0	43.1	707
50	165	125	4 × Ø18	25.0	54.5	828

Surface roughness (flange): EN 1092-1 Form B1 (DIN 2526 Form C), Ra 3.2 to 12.5 µm

- 1) DN 8 with DN 15 flanges as standard

<b>Flange according to ASME B16.5, Cl 150</b> <b>1.4404 (F316/F316L)</b> <i>Order code for "Process connection", option AAW</i>						
DN [mm]	A [mm]	B [mm]	C [mm]	D [mm]	E [mm]	L [mm]
8 <sup>1)</sup>	90	60.3	4 × Ø15.7	17.1	15.7	336
15	90	60.3	4 × Ø15.7	17.1	15.7	440
25	110	79.4	4 × Ø15.7	17.6	26.7	580
40	125	98.4	4 × Ø15.7	18.6	40.9	707
50	150	120.7	4 × Ø19.1	25.1	52.6	828
Surface roughness (flange): Ra 3.2 to 6.3 µm						

1) DN 8 with DN 15 flanges as standard

<b>Flange JIS B2220, 10K</b> <b>1.4404 (F316/F316L)</b> <i>Order code for "Process connection", option NDW</i>						
DN [mm]	A [mm]	B [mm]	C [mm]	D [mm]	E [mm]	L [mm]
50	155	120	4 × Ø19.0	16	50	828
Surface roughness (flange): Ra 3.2 to 6.3 µm						

<b>Flange JIS B2220, 20K</b> <b>1.4404 (F316/F316L)</b> <i>Order code for "Process connection", option NEW</i>						
DN [mm]	A [mm]	B [mm]	C [mm]	D [mm]	E [mm]	L [mm]
8 <sup>1)</sup>	95	70	4 × Ø15	16.0	15	336
15	95	70	4 × Ø15	16.0	15	440
25	125	90	4 × Ø19	17.5	25	580
40	140	105	4 × Ø19	20.0	40	707
50	155	120	8 × Ø19	27.5	50	828
Surface roughness (flange): Ra 3.2 to 6.3 µm						

1) DN 8 with DN 15 flanges as standard

Fixed flange DIN 11864-2

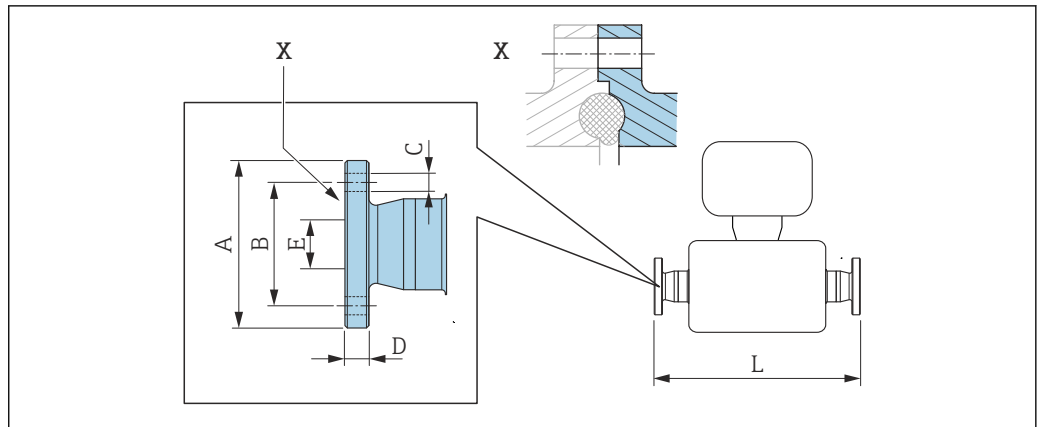

A0015627

34 Detail X: Asymmetrical process connection; the part shown in gray is provided by the supplier.

**i** Length tolerance for dimension L in mm:  
+1.5 / -2.0

**Flange DIN 11864-2 Form A, for pipe according to DIN11866 series A, flange with notch 1.4435 (316L)**

Order code for "Process connection", option KKW

DN [mm]	A [mm]	B [mm]	C [mm]	D [mm]	E [mm]	L [mm]
8	59.0	42	4 × Ø9	10	16.00	384
15	59.0	42	4 × Ø9	10	16.00	488
25	70	53	4 × Ø9	10	26.00	626
40	82	65	4 × Ø9	10	38.00	753
50	94	77	4 × Ø9	10	50.00	877

3-A version: order code for "Additional approval", option LP

**Clamp connections**

Tri-Clamp

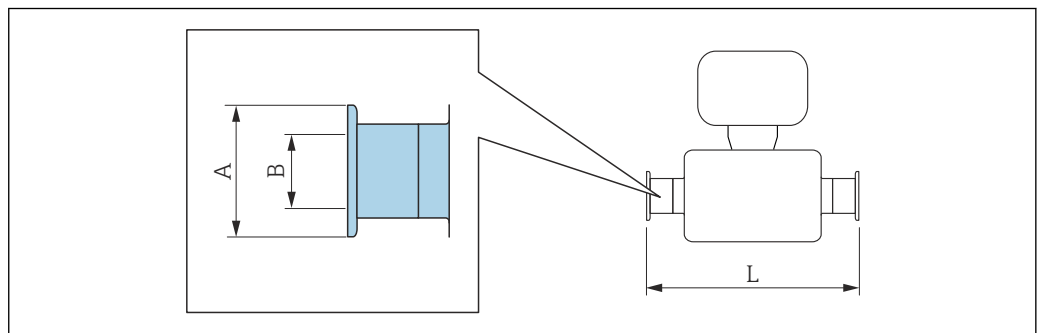

A0015625

**i** Length tolerance for dimension L in mm:  
+1.5 / -2.0

<b>¾" Tri-Clamp, for pipe according to DIN11866 series C 1.4435 (316L)</b>				
<i>Order code for "Process connection", option FEW</i>				
DN [mm]	Clamp [in]	A [mm]	B [mm]	L [mm]
8	¾	25.0	16.00	362
3-A version: order code for "Additional approval", option LP				

<b>½" Tri-Clamp, for pipe according to DIN11866 series C 1.4435 (316L)</b>				
<i>Order code for "Process connection", option FBW</i>				
DN [mm]	Clamp [in]	A [mm]	B [mm]	L [mm]
15	½	25.0	9.50	466
3-A version: order code for "Additional approval", option LP				

<b>1" Tri-Clamp, for pipe according to DIN11866 series C 1.4435 (316L)</b>				
<i>Order code for "Process connection", option FNW</i>				
DN [mm]	Clamp [in]	A [mm]	B [mm]	L [mm]
8	1	50.4	22.10	362
15	1	50.4	22.10	466
3-A version: order code for "Additional approval", option LP				

<b>1", 1½", 2" Tri-Clamp, for pipe according to DIN11866 series C 1.4435 (316L)</b>				
<i>Order code for "Process connection", option FTW</i>				
DN [mm]	Clamp [in]	A [mm]	B [mm]	L [mm]
8	½	25.0	9.50	362
15	¾	25.0	16.00	466
25	1	50.4	22.10	606
40	1½	50.4	34.80	731
50	2	63.9	47.50	853
3-A version: order code for "Additional approval", option LP				

Clamp connection DIN 11864-3

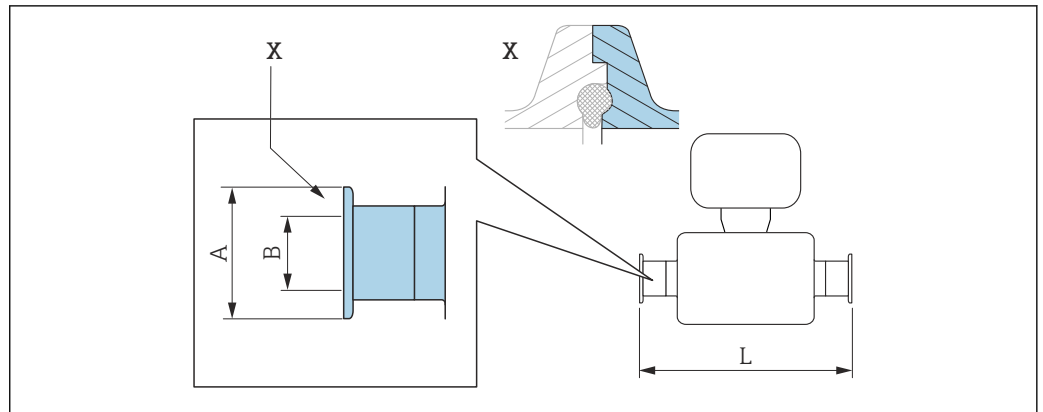

35 Detail X: Asymmetrical process connection; the part shown in gray is provided by the supplier.

**i** Length tolerance for dimension L in mm:  
+1.5 / -2.0

Clamp DIN 11864-3 Form A, with notch, for pipe according to DIN11866 series A 1.4435 (316L) Order code for "Process connection", option KMW			
DN [mm]	A [mm]	B [mm]	L [mm]
8	34.0	16.05	370
15	34.0	16.05	474
25	50.5	26.05	614
40	64.0	38.05	738
50	77.5	50.05	853

3-A version: order code for "Additional approval", option LP

Clamp connection DIN 32676, ISO 2852

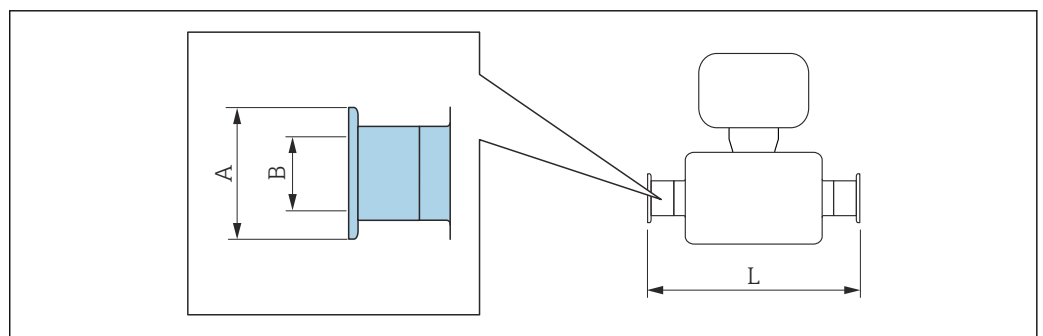

**i** Length tolerance for dimension L in mm:  
+1.5 / -2.0

<b>Clamp DIN 32676, for pipe according to DIN11866 series A 1.4435 (316L)</b>			
<i>Order code for "Process connection", option KQW</i>			
<b>DN [mm]</b>	<b>A [mm]</b>	<b>B [mm]</b>	<b>L [mm]</b>
8	34.0	16.00	362
15	34.0	16.00	466
25	50.5	26.00	606
40	50.5	38.00	732
50	64.0	50.00	854
3-A version: order code for "Additional approval", option LP			

<b>Clamp ISO 2852 , for pipe according to ISO 2037 1.4435 (316L)</b>			
<i>Order code for "Process connection", option JSA</i>			
<b>DN [mm]</b>	<b>A [mm]</b>	<b>B [mm]</b>	<b>L [mm]</b>
8	50.5	22.6	362
15	50.5	22.6	466
25	50.5	22.6	606
40	50.5	35.6	731
50	64.0	48.6	853
3-A version: order code for "Additional approval", option LP			

### Threaded glands

*Thread DIN 11851, DIN 11864-1, SMS 1145*

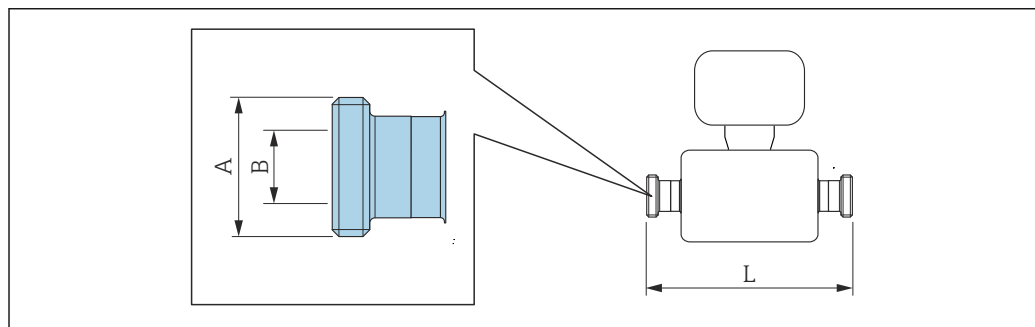

A0015628

**i** Length tolerance for dimension L in mm:  
+1.5 / -2.0

<b>Thread DIN 11851, Rd 28 × 1/8, for pipe according to DIN11866 series A 1.4435 (316L)</b>			
<i>Order code for "Process connection", option KAW</i>			
<b>DN [mm]</b>	<b>A [mm]</b>	<b>B [mm]</b>	<b>L [mm]</b>
8	Rd 28 × 1/8	10.00	362
15	Rd 28 × 1/8	10.00	466
3-A version: order code for "Additional approval", option LP			

<b>Thread DIN 11851, <math>\geq</math> Rd <math>34 \times \frac{1}{8}</math>, for pipe according to DIN11866 series A 1.4435 (316L)</b>			
<i>Order code for "Process connection", option KCW</i>			
<b>DN [mm]</b>	<b>A [mm]</b>	<b>B [mm]</b>	<b>L [mm]</b>
8	Rd $34 \times \frac{1}{8}$	16	362
15	Rd $34 \times \frac{1}{8}$	16	466
25	Rd $52 \times \frac{1}{6}$	26	606
40	Rd $65 \times \frac{1}{6}$	38	738
50	Rd $78 \times \frac{1}{6}$	50	864
3-A version: order code for "Additional approval", option LP			

<b>Thread DIN 11864-1 Form A, for pipe according to DIN11866 series A 1.4435 (316L)</b>			
<i>Order code for "Process connection", option KHW</i>			
<b>DN [mm]</b>	<b>A [mm]</b>	<b>B [mm]</b>	<b>L [mm]</b>
8	Rd $28 \times \frac{1}{8}$	16.00	362
15	Rd $34 \times \frac{1}{8}$	16.00	466
25	Rd $52 \times \frac{1}{6}$	26.00	620
40	Rd $65 \times \frac{1}{6}$	38.00	738
50	Rd $78 \times \frac{1}{6}$	50.00	864
3-A version: order code for "Additional approval", option LP			

<b>Thread SMS 1145 1.4435 (316L)</b>			
<i>Order code for "Process connection", option SAW</i>			
<b>DN [mm]</b>	<b>A [mm]</b>	<b>B [mm]</b>	<b>L [mm]</b>
8	Rd $40 \times \frac{1}{6}$	22.5	362
15	Rd $40 \times \frac{1}{6}$	22.5	466
25	Rd $40 \times \frac{1}{6}$	22.5	606
40	Rd $60 \times \frac{1}{6}$	35.5	742
50	Rd $70 \times \frac{1}{6}$	48.5	864
3-A version: order code for "Additional approval", option LP			

Thread ISO 2853

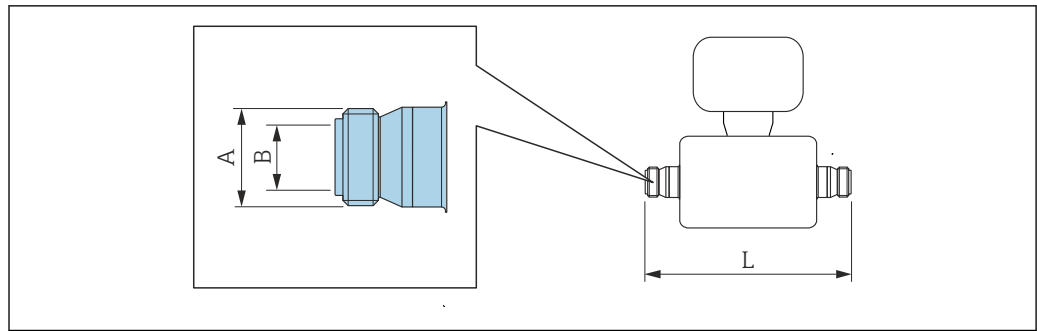

A0015623

**i** Length tolerance for dimension L in mm:  
+1.5 / -2.0

Thread ISO 2853, for pipe according to ISO 2037 1.4435 (316L) Order code for "Process connection", option JSE			
DN [mm]	A [mm]	B [mm]	L [mm]
8	37.13	22.60	370
15	37.13	22.60	474
25	37.13	22.60	614
40	50.65	35.60	742
50	64.10	48.60	864

3-A version: order code for "Additional approval", option LP

Accessories

Rinse connections

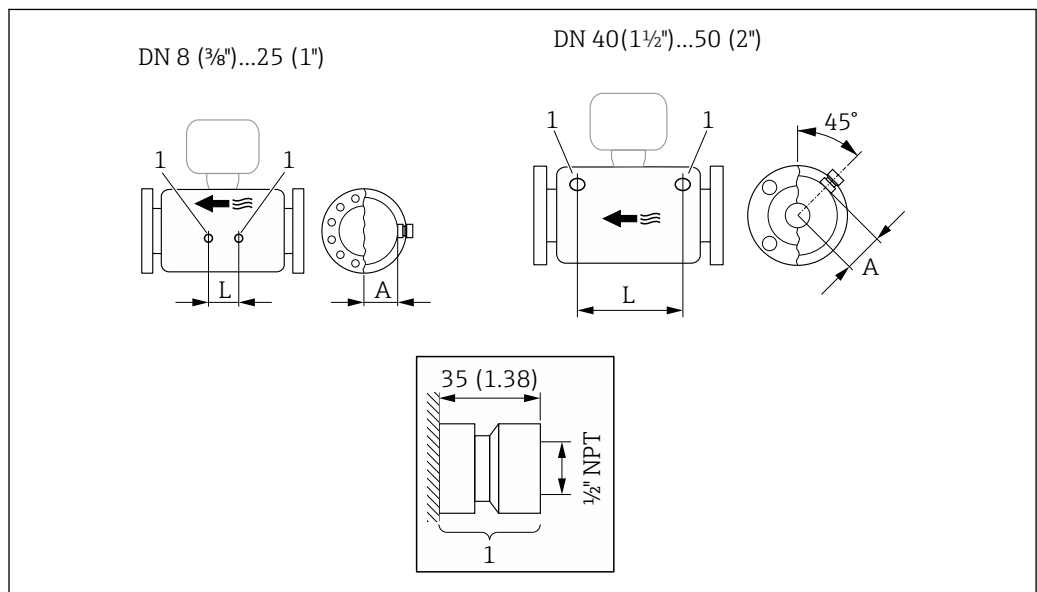

A0029971

**i** 36

1 Connection nipple for purge connections: order code for "Sensor options", option CH "Purge connection"



DN	A	L
[mm]	[mm]	[mm]
8	47	110
15	47	204
25	47	348
40	68.15	418
50	81.65	473

Protective cover

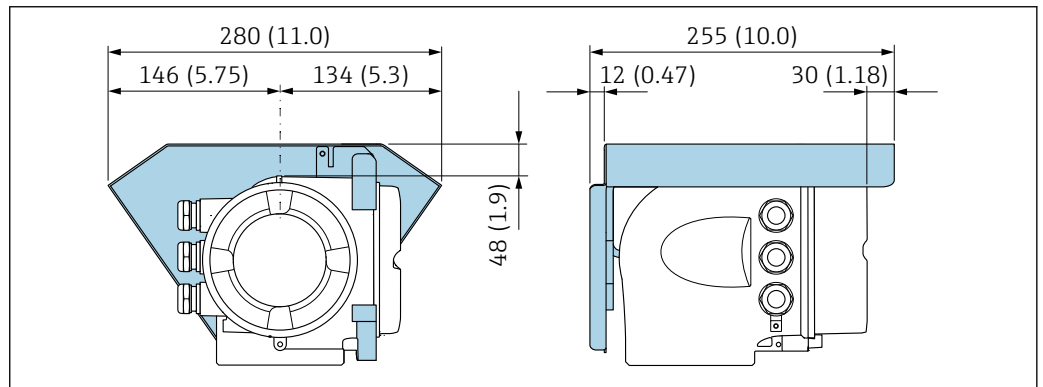

A0029553

Remote display and operating module DKX001

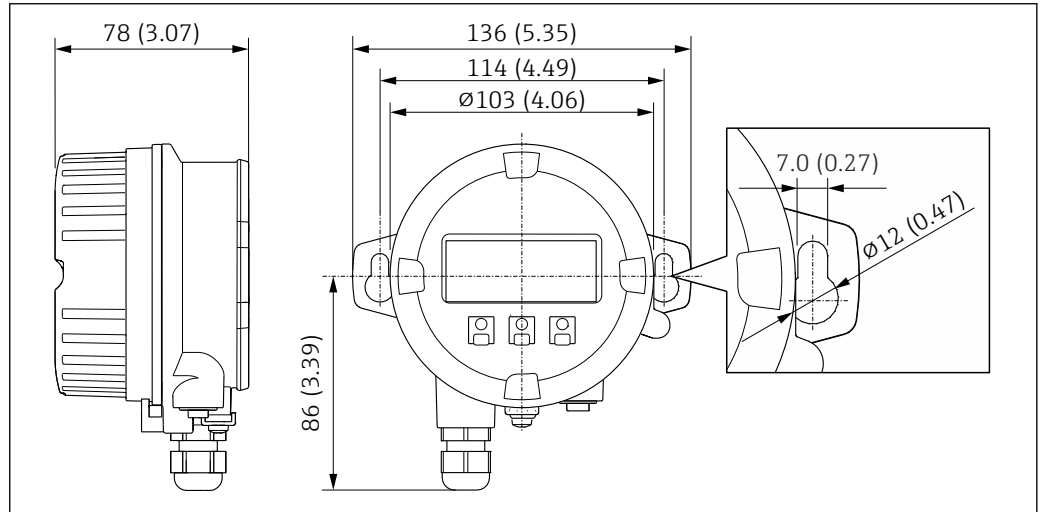

A0028921

37 Engineering unit mm (in)

External WLAN antenna

**i** The external WLAN antenna is not suitable for use in hygienic applications.

External WLAN antenna mounted on device

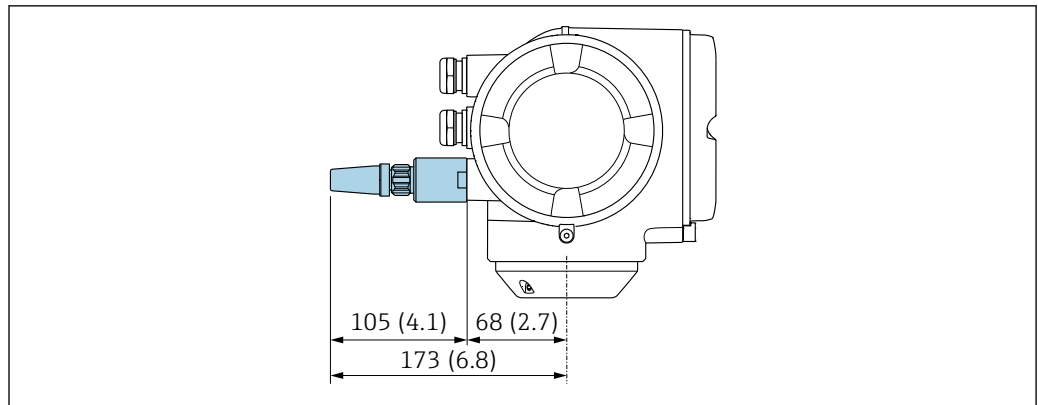

A0028923

38 Engineering unit mm (in)

External WLAN antenna mounted with cable

The external WLAN antenna can be mounted separately from the transmitter if the transmission/reception conditions at the transmitter mounting location are poor.

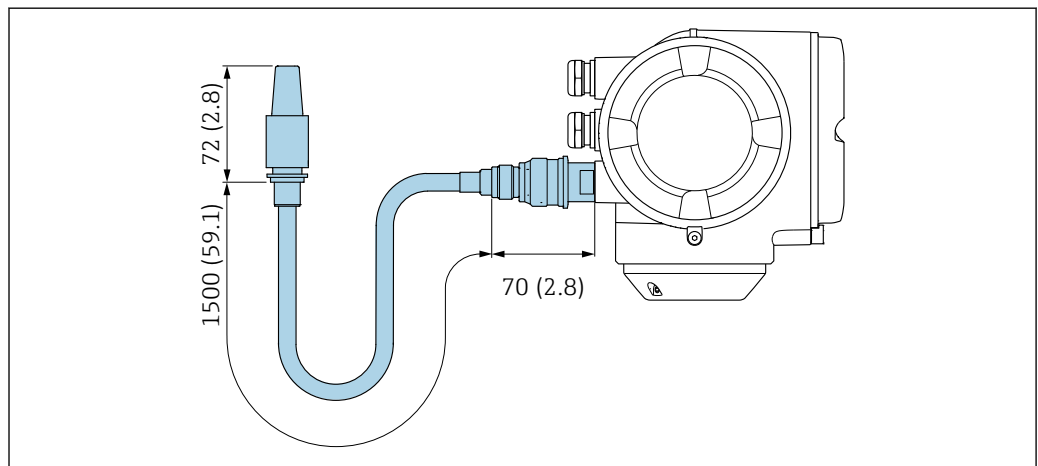

A0033597

39 Engineering unit mm (in)

Dimensions in US units

Compact version

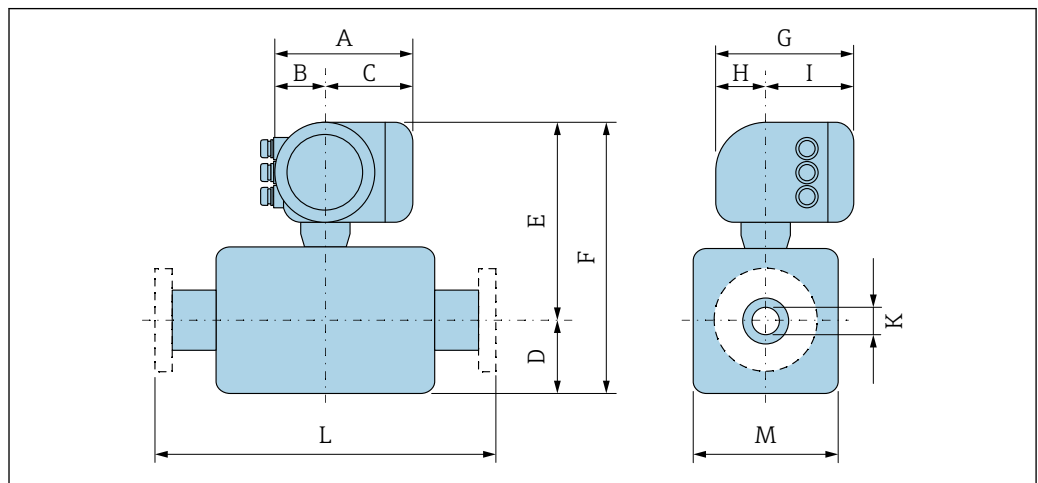

A0033783

*Order code for "Housing", option A "Aluminum, coated"*

DN [in]	A <sup>1)</sup> [in]	B <sup>1)</sup> [in]	C [in]	D [in]	E <sup>2)</sup> [in]	F <sup>2)</sup> [in]	G <sup>3)</sup> [in]	H [in]	I <sup>3)</sup> [in]	K [in]	L [in]	M [in]
$\frac{3}{8}$	6.65	2.68	3.98	4.25	10.47	14.72	7.87	2.32	5.55	0.33	<sup>4)</sup>	3.62
$\frac{1}{2}$	6.65	2.68	3.98	4.25	10.47	14.72	7.87	2.32	5.55	0.47	<sup>4)</sup>	3.62
1	6.65	2.68	3.98	4.76	10.47	15.24	7.87	2.32	5.55	0.69	<sup>4)</sup>	3.62
$1\frac{1}{2}$	6.65	2.68	3.98	6.93	11.69	18.7	7.87	2.32	5.55	1.02	<sup>4)</sup>	5.59
2	6.65	2.68	3.98	10.24	12.2	22.52	7.87	2.32	5.55	1.49	<sup>4)</sup>	6.65

- 1) Depending on the cable gland used: values up to + 1.18 in
- 2) With order code for "Sensor option", option CG: values +2.76 in
- 3) For version without local display: values - 1.18 in
- 4) Depends on the process connection in question

*Order code for "Housing", option A "Aluminum, coated"; Ex d*

DN [in]	A <sup>1)</sup> [in]	B <sup>1)</sup> [in]	C [in]	D [in]	E <sup>2)</sup> [in]	F <sup>2)</sup> [in]	G <sup>3)</sup> [in]	H [in]	I <sup>3)</sup> [in]	K [in]	L [in]	M [in]
$\frac{3}{8}$	7.40	3.35	4.06	4.25	10.94	15.91	8.54	2.28	5.83	0.33	<sup>4)</sup>	3.62
$\frac{1}{2}$	7.40	3.35	4.06	4.25	10.94	15.91	8.54	2.28	5.83	0.47	<sup>4)</sup>	3.62
1	7.40	3.35	4.06	4.76	10.94	16.42	8.54	2.28	5.83	0.69	<sup>4)</sup>	3.62
$1\frac{1}{2}$	7.40	3.35	4.06	6.93	12.13	19.88	8.54	2.28	5.83	1.02	<sup>4)</sup>	5.59
2	7.40	3.35	4.06	10.24	12.68	23.7	8.54	2.28	5.83	1.49	<sup>4)</sup>	6.65

- 1) Depending on the cable gland used: values up to + 1.18 in
- 2) With order code for "Sensor option", option CG: values +2.76 in
- 3) For version without local display: values - 1.93 in
- 4) Depends on the process connection in question

*Order code for "Housing", option B "Stainless, hygienic"*

DN [in]	A <sup>1)</sup> [in]	B <sup>1)</sup> [in]	C [in]	D [in]	E <sup>2)</sup> [in]	F <sup>2)</sup> [in]	G [in]	H [in]	I [in]	K [in]	L [in]	M [in]
$\frac{3}{8}$	7.20	2.87	4.33	4.25	10.47	14.72	8.15	2.56	5.59	0.33	<sup>3)</sup>	3.62
$\frac{1}{2}$	7.20	2.87	4.33	4.25	10.47	14.72	8.15	2.56	5.59	0.47	<sup>3)</sup>	3.62
1	7.20	2.87	4.33	4.76	10.47	15.24	8.15	2.56	5.59	0.69	<sup>3)</sup>	3.62
$1\frac{1}{2}$	7.20	2.87	4.33	6.93	11.69	18.70	8.15	2.56	5.59	1.02	<sup>3)</sup>	5.59
2	7.20	2.87	4.33	10.24	12.20	22.52	8.15	2.56	5.59	1.49	<sup>3)</sup>	6.65

- 1) Depending on the cable gland used: values up to + 1.18 in
- 2) With order code for "Sensor option", option CG: values +2.76 in
- 3) Depends on the process connection in question

**Flange connections ASME B16.5**

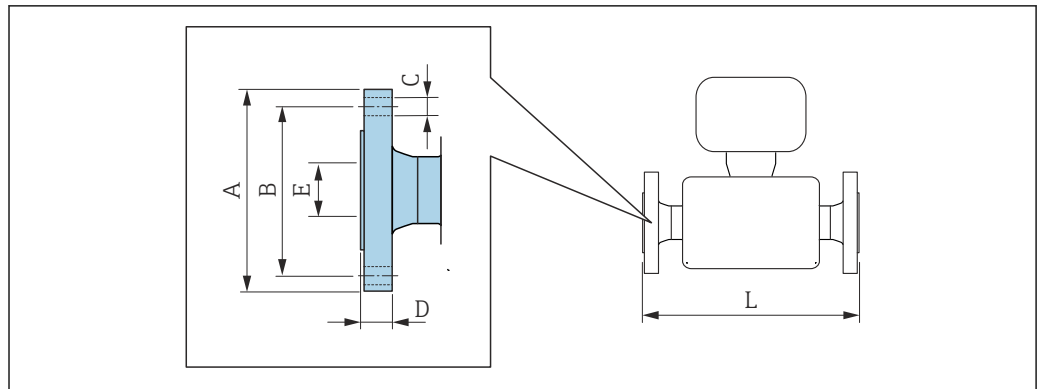

A0015621

**i** Length tolerance for dimension L in inch:  
+0.06 / -0.08

**Flange according to ASME B16.5, Cl 150  
1.4404 (316/316L)**

Order code for "Process connection", option AAW

DN [in]	A [in]	B [in]	C [in]	D [in]	E [in]	L [in]
3/8 <sup>1)</sup>	3.54	2.37	4 × Ø0.62	0.67	0.62	13.23
1/2	3.54	2.37	4 × Ø0.62	0.67	0.62	17.32
1	4.33	3.13	4 × Ø0.62	0.69	1.05	22.83
1½	4.92	3.87	4 × Ø0.62	0.73	1.61	27.83
2	5.91	4.75	4 × Ø0.75	0.99	2.07	32.6

Surface roughness (flange): Ra 126 to 248 µin

1) DN 3/8" with DN 1/2" flanges as standard

**Tri-Clamp**

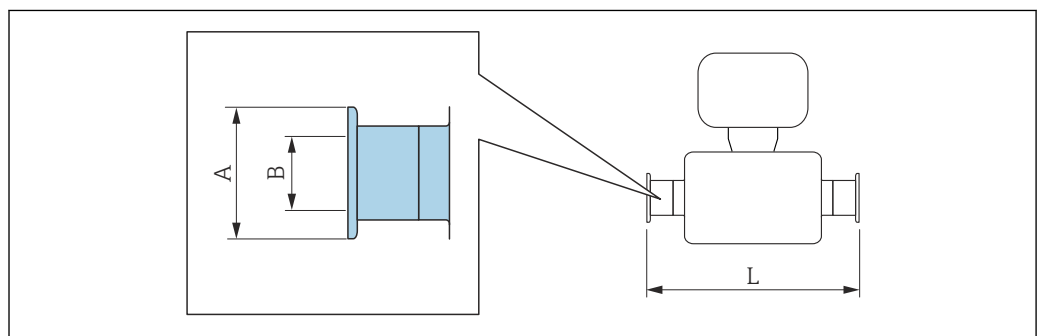

A0015625

**i** Length tolerance for dimension L in inch:  
+0.06 / -0.08

**3/4" Tri-Clamp, for pipe according to DIN 11866 series C  
1.4435 (316L)**  
Order code for "Process connection", option FEW

DN [in]	Clamp [in]	A [in]	B [in]	L [in]
3/8	3/4	0.98	0.63	14.25

3-A version: order code for "Additional approval", option LP

**1/2" Tri-Clamp, for pipe according to DIN 11866 series C  
1.4435 (316L)**  
Order code for "Process connection", option FBW

DN [in]	Clamp [in]	A [in]	B [in]	L [in]
1/2	1/2	0.98	0.37	18.35

3-A version: order code for "Additional approval", option LP

**1" Tri-Clamp, for pipe according to DIN 11866 series C  
1.4435 (316L)**  
Order code for "Process connection", option FNW

DN [in]	Clamp [in]	A [in]	B [in]	L [in]
3/8	1	1.98	0.87	14.25
1/2	1	1.98	0.87	18.35

3-A version: order code for "Additional approval", option LP

**1", 1 1/2", 2" Tri-Clamp, for pipe according to DIN 11866 series C  
1.4435 (316L)**  
Order code for "Process connection", option FTW

DN [in]	Clamp [in]	A [in]	B [in]	L [in]
3/8	1/2	0.98	0.37	14.25
1/2	3/4	0.98	0.63	18.35
1	1	1.98	0.87	23.86
1 1/2	1 1/2	1.98	1.37	28.78
2	2	2.52	1.87	33.58

3-A version: order code for "Additional approval", option LP

**Threaded connections SMS 1145**

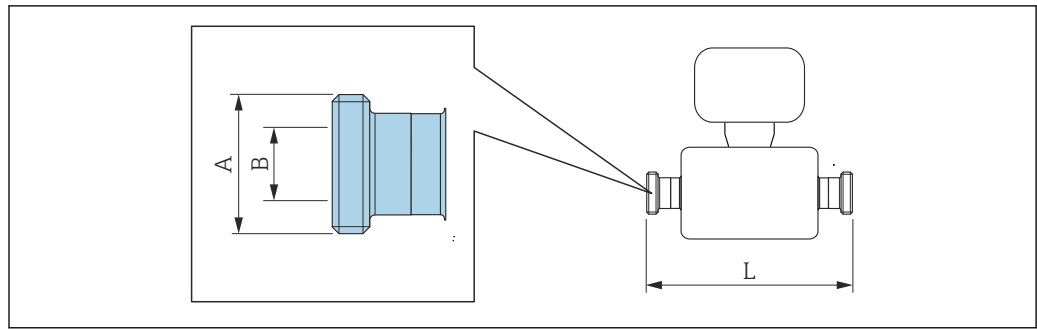

A0015628

**i** Length tolerance for dimension L in inch:  
+0.06 / -0.08

Thread SMS 1145 1.4435 (316L) Order code for "Process connection", option SAW			
DN [in]	A [in]	B [in]	L [in]
3/8	Rd 40 × 1/6	0.89	14.25
1/2	Rd 40 × 1/6	0.89	18.35
1	Rd 40 × 1/6	0.89	23.86
1 1/2	Rd 60 × 1/6	1.4	29.21
2	Rd 70 × 1/6	1.91	34.02

3-A version: order code for "Additional approval", option LP

**Accessories**

*Rinse connections*

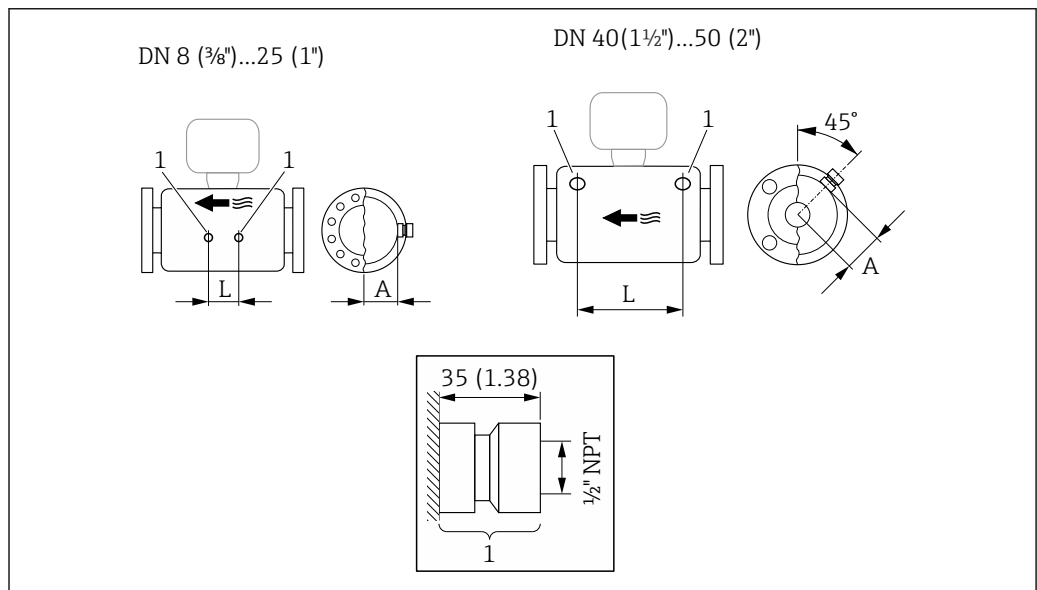

A0029971

**40**

1 Connection nipple for purge connections: order code for "Sensor options", option CH "Purge connection"

DN	A	L
[in]	[in]	[in]
3/8	1.85	4.33
1/2	1.85	8.03
1	1.85	13.7
1 1/2	2.683	16.46
2	3.215	18.62

Protective cover

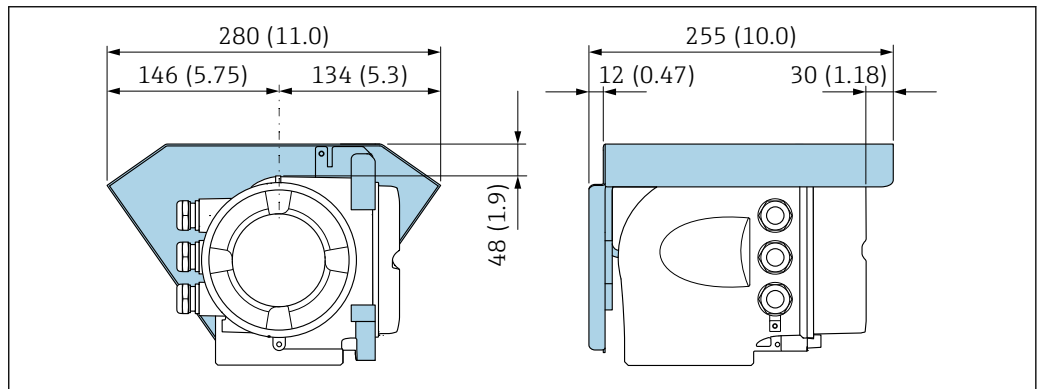

A0029553

Remote display and operating module DKX001

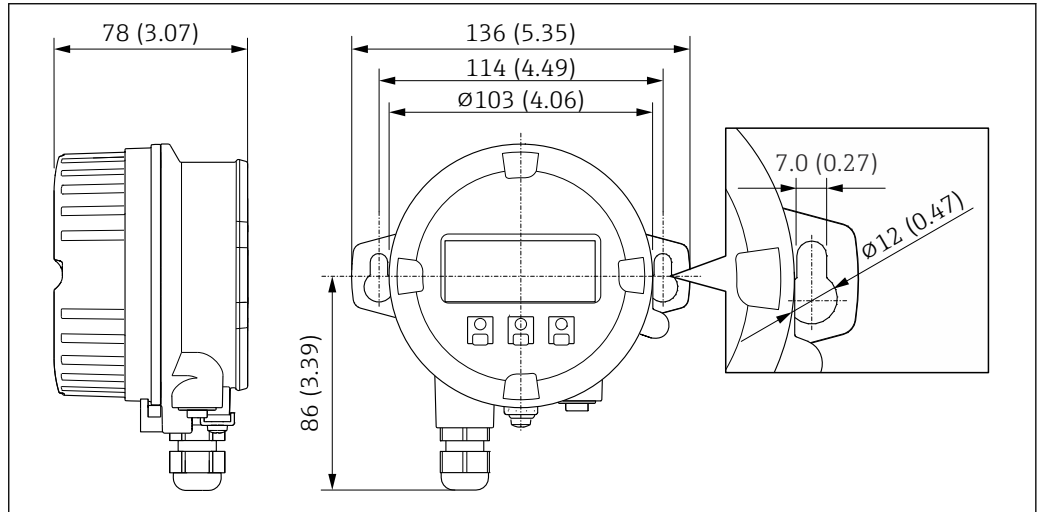

A0028921

41 Engineering unit mm (in)

External WLAN antenna

**i** The external WLAN antenna is not suitable for use in hygienic applications.

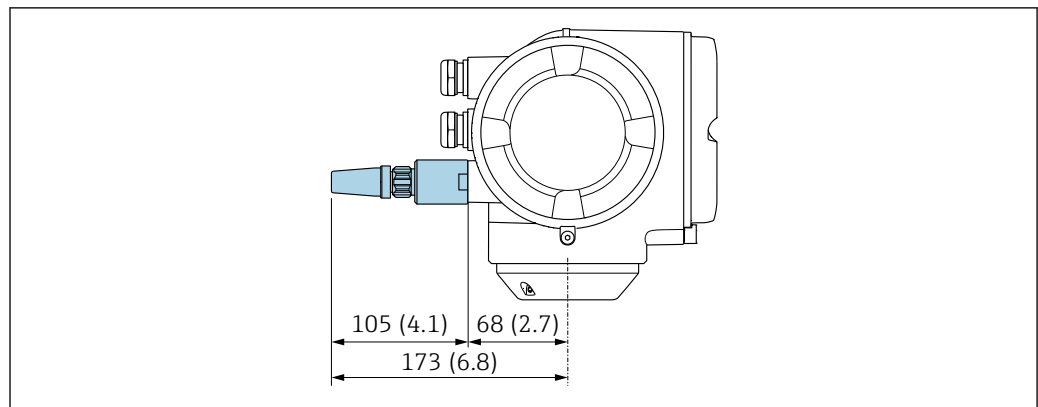
*External WLAN antenna mounted on device*

A0028923

42 Engineering unit mm (in)

*External WLAN antenna mounted with cable*

The external WLAN antenna can be mounted separately from the transmitter if the transmission/reception conditions at the transmitter mounting location are poor.

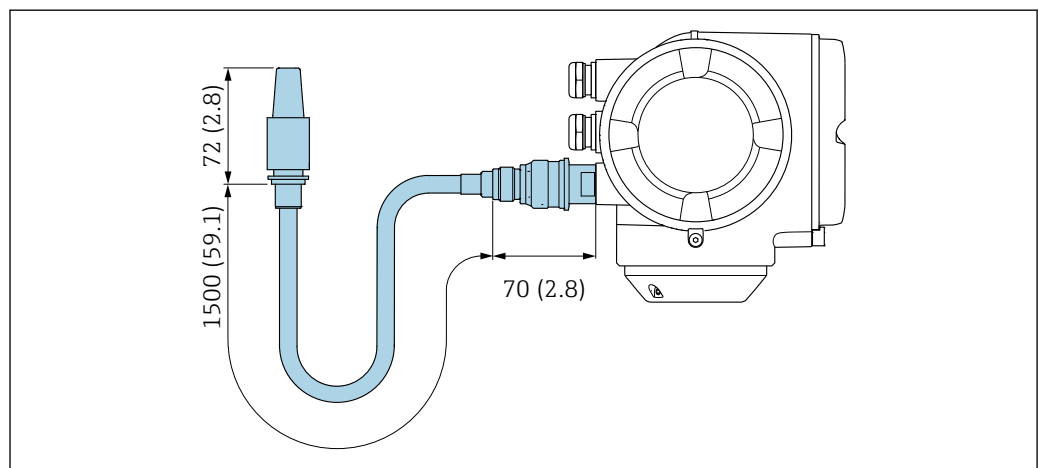

A0033597

43 Engineering unit mm (in)

**Weight**

All values (weight exclusive of packaging material) refer to devices with EN/DIN PN 40 flanges. Weight specifications including transmitter as per order code for "Housing", option A "Aluminum, coated".

Different values due to different transmitter versions:

- Transmitter version for the hazardous area  
(Order code for "Housing", option A "Aluminum, coated"; Ex d): +2 kg (+4.4 lbs)
- Transmitter version for hygienic area  
(Order code for "Housing", option B "Stainless, hygienic"): +0.2 kg (+0.44 lbs)

**Weight in SI units**

DN [mm]	Weight [kg]
8	13
15	15
25	20
40	38
50	61



**Weight in US units**

DN [in]	Weight [lbs]
3/8	29
1/2	33
1	44
1 1/2	84
2	134

**Materials**

**Transmitter housing**

Order code for "Housing":

- Option **A** "Aluminum, coated": aluminum, AlSi10Mg, coated
- Option **B** "Stainless, hygienic": stainless steel, 1.4404 (316L)

*Window material*

Order code for "Housing":

- Option **A** "Aluminum, coated": glass
- Option **B** "Stainless, hygienic": polycarbonate

*Seals*

Order code for "Housing":

- Option **B** "Stainless, hygienic": EPDM and silicone

**Cable entries/cable glands**

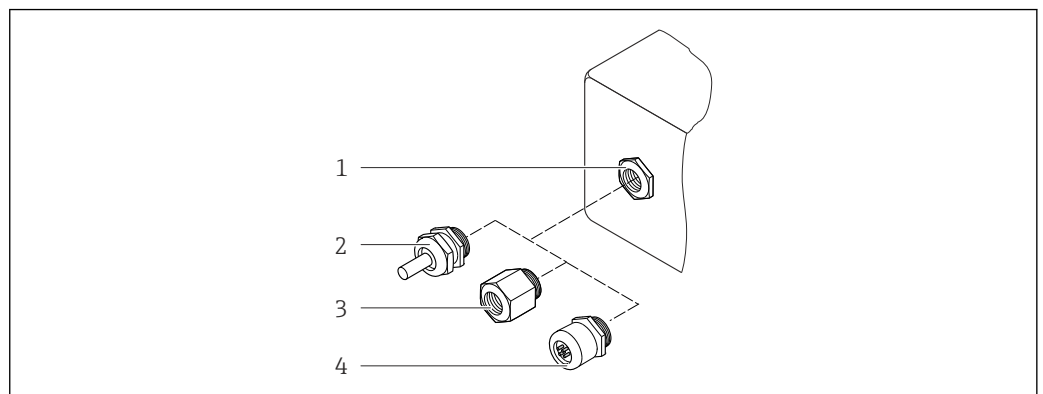

A0028352

44 Possible cable entries/cable glands

- 1 Female thread M20 × 1.5
- 2 Cable gland M20 × 1.5
- 3 Adapter for cable entry with internal thread G 1/2" or NPT 1/2"
- 4 Device plugs

Order code for "Housing", option A "Aluminum, coated"

The various cable entries are suitable for hazardous and non-hazardous areas.

Cable entry/cable gland	Material
Coupling M20 × 1.5	Non-Ex: plastic
	Z2, D2, Ex d/de: brass with plastic
Adapter for cable entry with internal thread G 1/2"	Nickel-plated brass
Adapter for cable entry with internal thread NPT 1/2"	

Order code for "Housing", option B "Stainless, hygienic"

The various cable entries are suitable for hazardous and non-hazardous areas.

Cable entry/cable gland	Material
Cable gland M20 × 1.5	Plastic
Adapter for cable entry with internal thread G ½"	Nickel-plated brass
Adapter for cable entry with internal thread NPT ½"	

### Device plug

Electrical connection	Material
Plug M12x1	<ul style="list-style-type: none"> <li>■ Socket: Stainless steel, 1.4404 (316L)</li> <li>■ Contact housing: Polyamide</li> <li>■ Contacts: Gold-plated brass</li> </ul>

### Sensor housing



- Acid and alkali-resistant outer surface
- Stainless steel 1.4301 (304)

### Measuring tubes

Stainless steel, 1.4435 (316L)

### Process connections

<b>Flange according to EN 1092-1 (DIN 2501)/ASME B16.5/JIS B2220:</b>	Stainless steel, 1.4404 (316/316L)
<b>All other process connections:</b>	Stainless steel, 1.4435 (316L)

 Available process connections →  79

### Seals

Welded process connections without internal seals

### Accessories

#### Protective cover

Stainless steel, 1.4404 (316L)

#### External WLAN antenna

- Antenna: ASA plastic (acrylic ester-styrene-acrylonitrile) and nickel-plated brass
- Adapter: Stainless steel and nickel-plated brass
- Cable: Polyethylene
- Plug: Nickel-plated brass
- Angle bracket: Stainless steel

**Process connections**

- Fixed flange connections:
  - EN 1092-1 (DIN 2501) flange
  - EN 1092-1 (DIN 2512N) flange
  - ASME B16.5 flange
  - JIS B2220 flange
  - DIN 11864-2 Form A flange, DIN 11866 series A, flange with notch
- Clamp connections:
  - Tri-Clamp (OD tubes), DIN 11866 series C
  - DIN 11864-3 Form A clamp, DIN 11866 series A, with notch
  - DIN 32676 clamp, DIN 11866 series A
  - ISO 2852 clamp, ISO 2037
- Thread:
  - DIN 11851 thread, DIN 11866 series A
  - SMS 1145 thread
  - ISO 2853 thread, ISO 2037
  - DIN 11864-1 Form A thread, DIN 11866 series A



Process connection materials → 78

**Surface roughness**

All data relate to parts in contact with fluid. The following surface roughness quality can be ordered.

- $Ra_{max} = 0.76 \mu\text{m}$  (30  $\mu\text{in}$ )
- $Ra_{max} = 0.38 \mu\text{m}$  (15  $\mu\text{in}$ )

## Human interface

**Operating concept****Operator-oriented menu structure for user-specific tasks**

- Commissioning
- Operation
- Diagnostics
- Expert level

**Fast and safe commissioning**

- Guided menus ("Make-it-run" wizards) for applications
- Menu guidance with brief descriptions of the individual parameter functions
- Access to the device via Web server → 98
- WLAN access to the device via mobile handheld terminal, tablet or smart phone

**Reliable operation**

- Operation in local language → 79
- Uniform operating philosophy applied to device and operating tools
- If replacing electronic modules, transfer the device configuration via the integrated memory (HistoROM backup) which contains the process and measuring device data and the event logbook. No need to reconfigure.

**Efficient diagnostics increase measurement availability**

- Troubleshooting measures can be called up via the device and in the operating tools
- Diverse simulation options, logbook for events that occur and optional line recorder functions

**Languages**

Can be operated in the following languages:

- Via local operation
  - English, German, French, Spanish, Italian, Dutch, Portuguese, Polish, Russian, Turkish, Chinese, Japanese, Korean, Bahasa (Indonesian), Vietnamese, Czech, Swedish
- Via Web browser
  - English, German, French, Spanish, Italian, Dutch, Portuguese, Polish, Russian, Turkish, Chinese, Japanese, Korean, Bahasa (Indonesian), Vietnamese, Czech, Swedish
- Via "FieldCare", "DeviceCare" operating tool: English, German, French, Spanish, Italian, Chinese, Japanese

## Local operation

## Via display module

Equipment:

- Order code for "Display; operation", option F "4-line, illuminated, graphic display; touch control"
- Order code for "Display; operation", option G "4-line, illuminated, graphic display; touch control + WLAN"

 Information about WLAN interface →  86

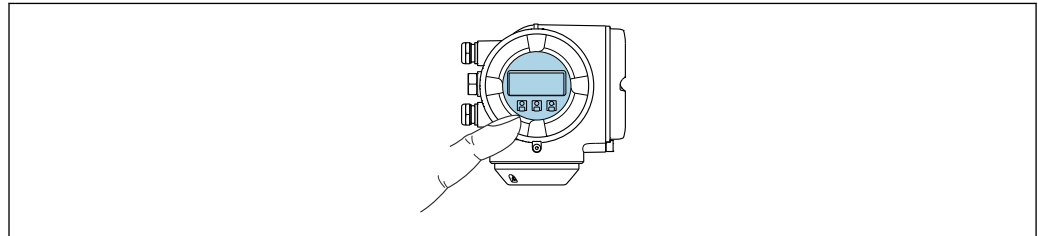



A0026785

 45 Operation with touch control

## Display elements

- 4-line, illuminated, graphic display
- White background lighting; switches to red in event of device errors
- Format for displaying measured variables and status variables can be individually configured
- Permitted ambient temperature for the display:  $-20$  to  $+60$  °C ( $-4$  to  $+140$  °F)  
The readability of the display may be impaired at temperatures outside the temperature range.

## Operating elements

- External operation via touch control (3 optical keys) without opening the housing: , , 
- Operating elements also accessible in the various zones of the hazardous area

## Via remote display and operating module DKX001

 The remote display and operating module DKX001 is available as an optional extra →  96.

- The remote display and operating module DKX001 is only available for the following housing version: order code for "Housing": option A "Aluminum, coated"
- The measuring device is always supplied with a dummy cover when the remote display and operating module DKX001 is ordered directly with the measuring device. Display or operation at the transmitter is not possible in this case.
- If ordered subsequently, the remote display and operating module DKX001 may not be connected at the same time as the existing measuring device display module. Only one display or operation unit may be connected to the transmitter at any one time.

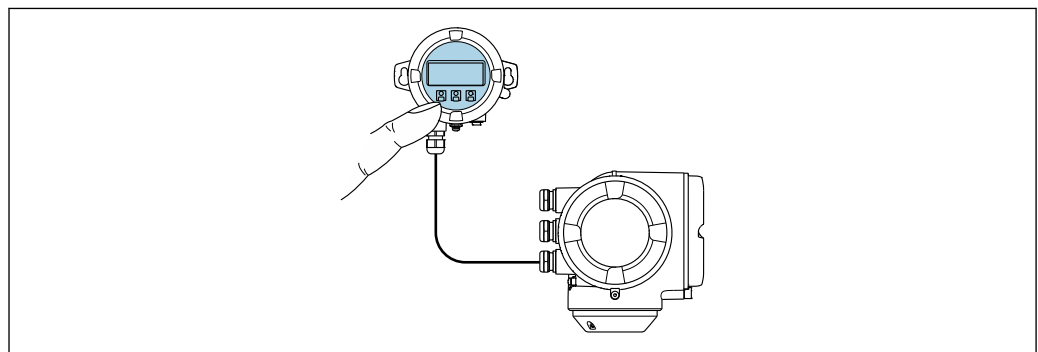

A0026786

 46 Operation via remote display and operating module DKX001

## Display and operating elements

The display and operating elements correspond to those of the display module →  80.

*Material*

The housing material of the display and operating module DKX001 depends on the choice of transmitter housing material.

Transmitter housing		Remote display and operating module
Order code for "Housing"	Material	Material
Option A "Aluminum, coated"	AlSi10Mg, coated	AlSi10Mg, coated

*Cable entry*

Corresponds to the choice of transmitter housing, order code for "Electrical connection".

*Connecting cable*

→ 44

*Dimensions*

→ 69

**Remote operation**

**Via HART protocol**

This communication interface is available in device versions with a HART output.

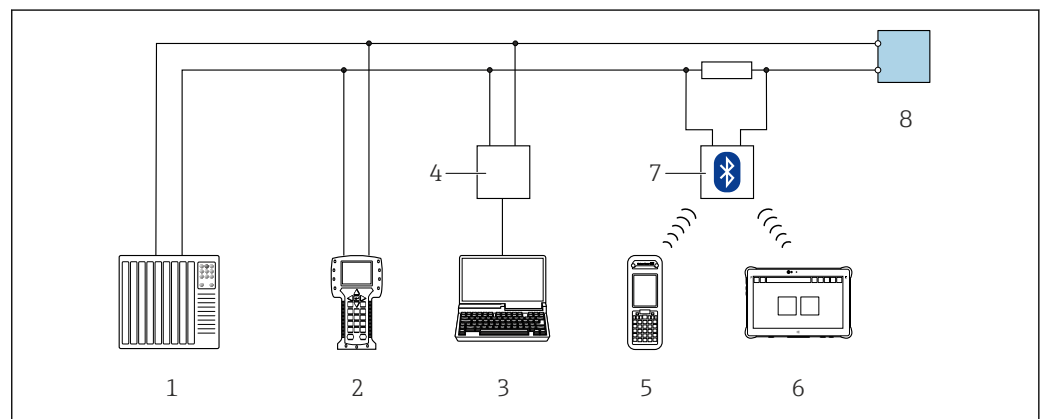

47 Options for remote operation via HART protocol (active)

- 1 Control system (e.g. PLC)
- 2 Field Communicator 475
- 3 Computer with Web browser (e.g. Internet Explorer) for access to the integrated device Web server or computer with an operating tool (e.g. FieldCare, DeviceCare, AMS Device Manager, SIMATIC PDM) with COM DTM "CDI Communication TCP/IP"
- 4 Commubox FXA195 (USB)
- 5 Field Xpert SFX350 or SFX370
- 6 Field Xpert SMT70
- 7 VIATOR Bluetooth modem with connecting cable
- 8 Transmitter

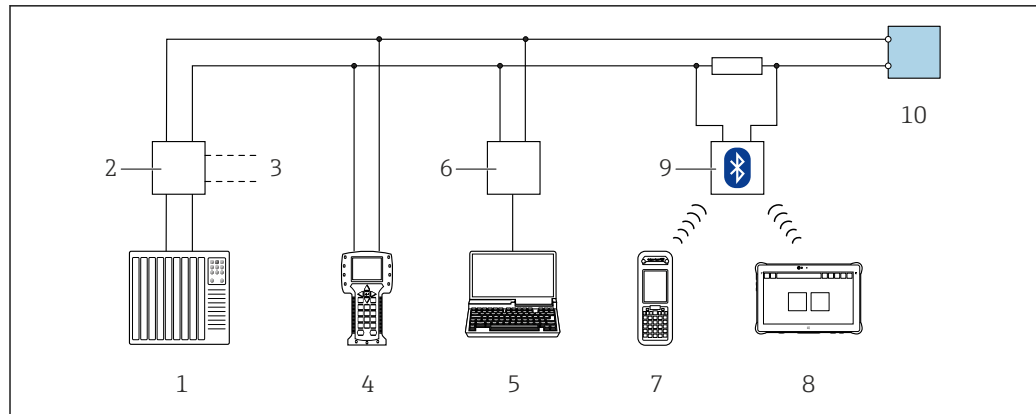

A0028746

48 Options for remote operation via HART protocol (passive)

- 1 Control system (e.g. PLC)
- 2 Transmitter power supply unit, e.g. RN221N (with communication resistor)
- 3 Connection for Commubox FXA195 and Field Communicator 475
- 4 Field Communicator 475
- 5 Computer with Web browser (e.g. Internet Explorer) for access to the integrated device Web server or computer with an operating tool (e.g. FieldCare, DeviceCare, AMS Device Manager, SIMATIC PDM) with COM DTM "CDI Communication TCP/IP"
- 6 Commubox FXA195 (USB)
- 7 Field Xpert SFX350 or SFX370
- 8 Field Xpert SMT70
- 9 VIATOR Bluetooth modem with connecting cable
- 10 Transmitter

#### Via FOUNDATION Fieldbus network

This communication interface is available in device versions with FOUNDATION Fieldbus.

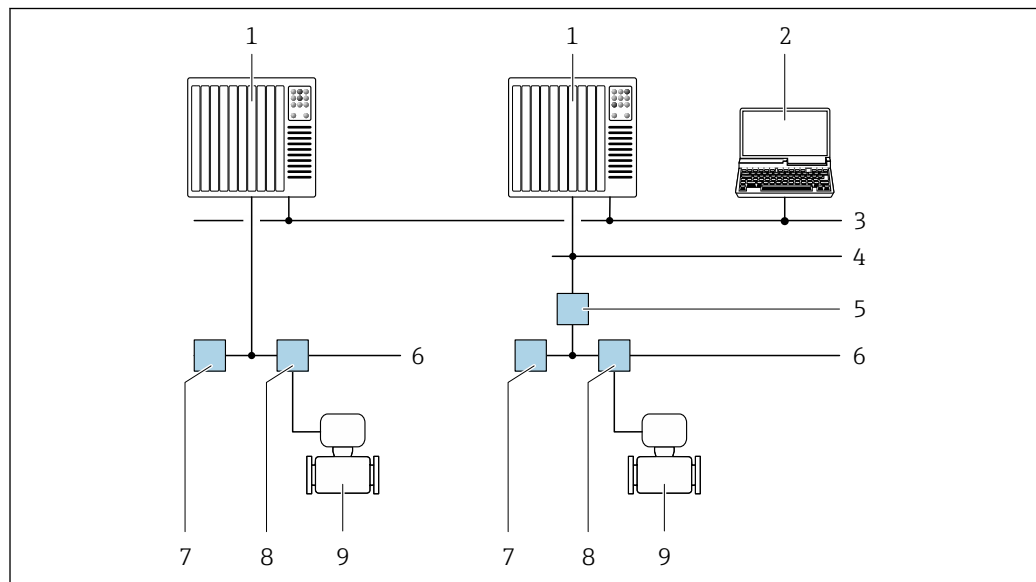

A0028837

49 Options for remote operation via FOUNDATION Fieldbus network

- 1 Automation system
- 2 Computer with FOUNDATION Fieldbus network card
- 3 Industry network
- 4 High Speed Ethernet FF-HSE network
- 5 Segment coupler FF-HSE/FF-H1
- 6 FOUNDATION Fieldbus FF-H1 network
- 7 Power supply FF-H1 network
- 8 T-box
- 9 Measuring device

**Via PROFIBUS DP network**

This communication interface is available in device versions with PROFIBUS DP.

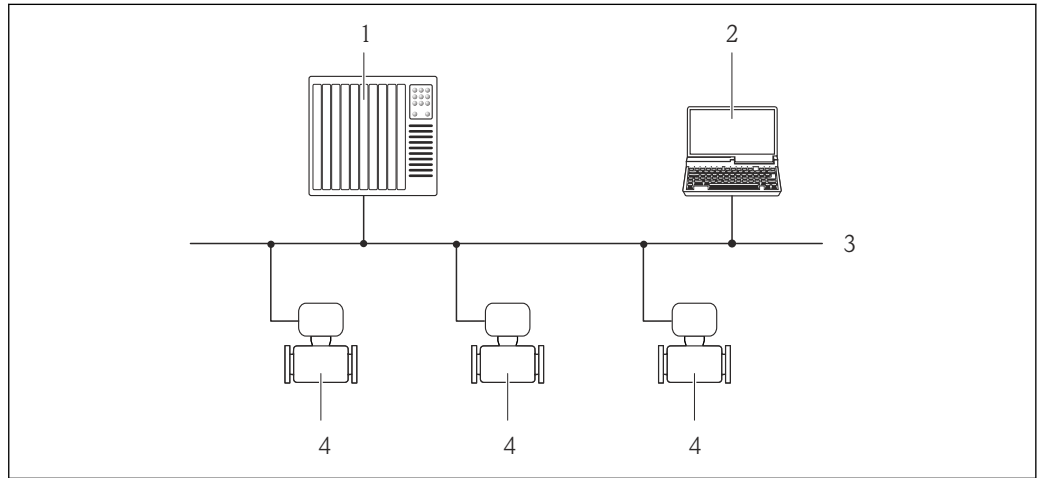

A0020903

50 Options for remote operation via PROFIBUS DP network

- 1 Automation system
- 2 Computer with PROFIBUS network card
- 3 PROFIBUS DP network
- 4 Measuring device

**Via PROFIBUS PA network**

This communication interface is available in device versions with PROFIBUS PA.

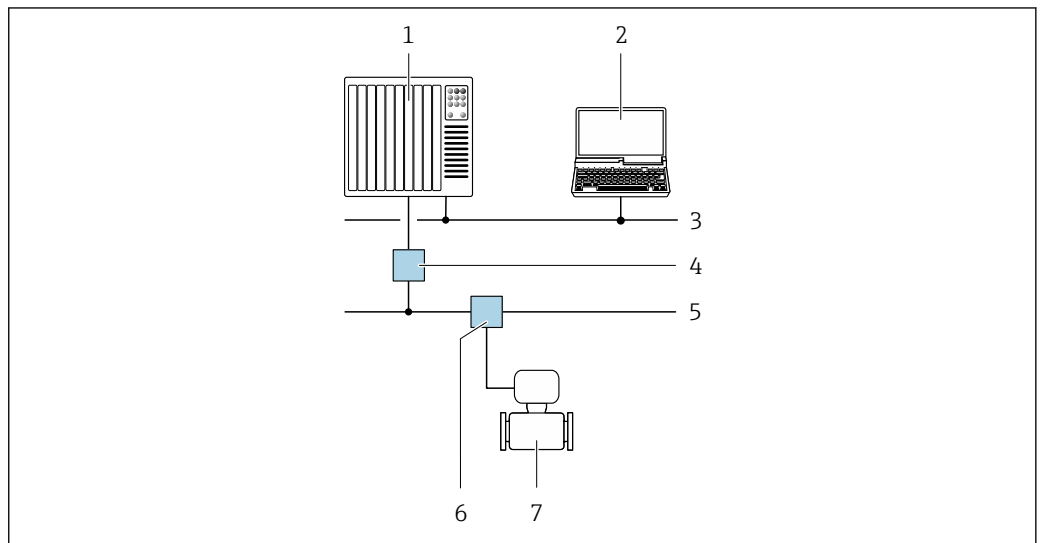

A0028838

51 Options for remote operation via PROFIBUS PA network

- 1 Automation system
- 2 Computer with PROFIBUS network card
- 3 PROFIBUS DP network
- 4 Segment coupler PROFIBUS DP/PA
- 5 PROFIBUS PA network
- 6 T-box
- 7 Measuring device

**Via Modbus RS485 protocol**

This communication interface is available in device versions with a Modbus-RS485 output.

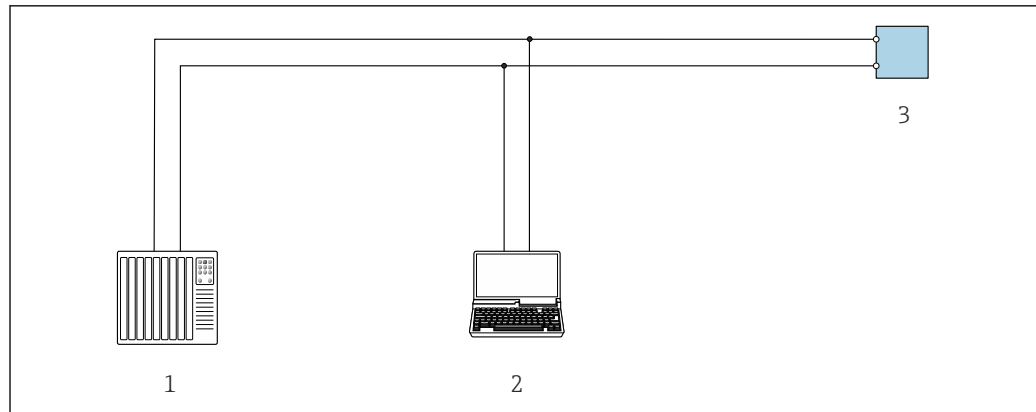

A0029437

52 Options for remote operation via Modbus-RS485 protocol (active)

- 1 Control system (e.g. PLC)
- 2 Computer with Web browser (e.g. Internet Explorer) for accessing the integrated device Web server or with operating tool (e.g. FieldCare, DeviceCare) with COM DTM "CDI Communication TCP/IP" or Modbus DTM
- 3 Transmitter

### Via EtherNet/IP network

This communication interface is available in device versions with EtherNet/IP.

#### Star topology

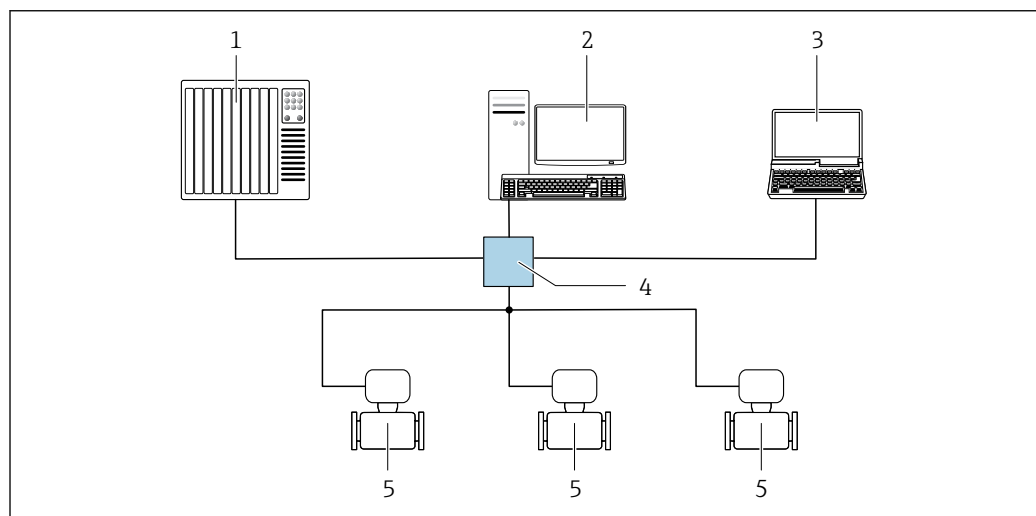

A0032078

53 Options for remote operation via EtherNet/IP network: star topology

- 1 Automation system, e.g. "RSLogix" (Rockwell Automation)
- 2 Workstation for measuring device operation: with Custom Add-On Profile for "RSLogix 5000" (Rockwell Automation) or with Electronic Data Sheet (EDS)
- 3 Computer with Web browser (e.g. Internet Explorer) for accessing the integrated device Web server or computer with operating tool (e.g. FieldCare, DeviceCare) with COM DTM "CDI Communication TCP/IP"
- 4 Ethernet switch
- 5 Measuring device

#### Ring topology

The device is integrated via the terminal connection for signal transmission (output 1) and the service interface (CDI-RJ45).



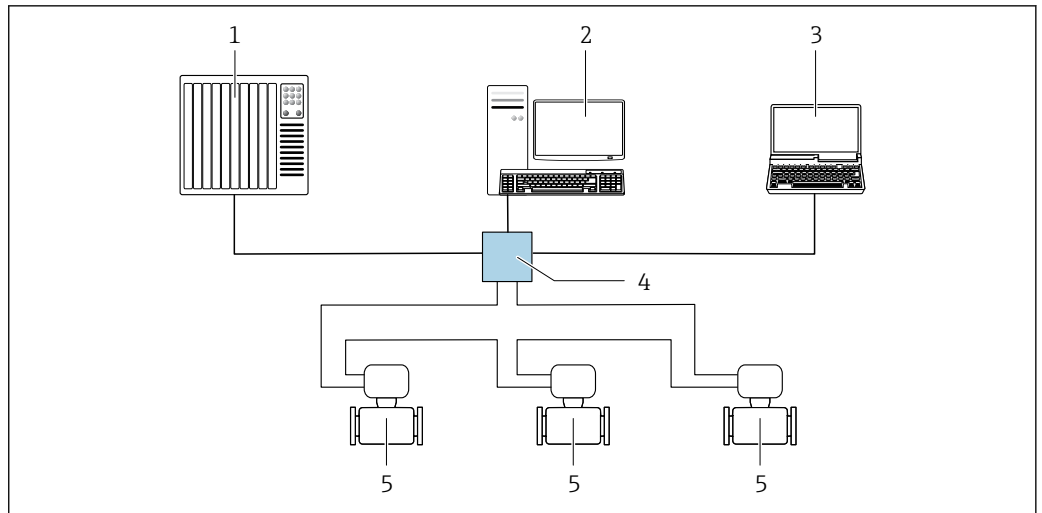

A0033725

54 Options for remote operation via EtherNet/IP network: ring topology

- 1 Automation system, e.g. "RSLogix" (Rockwell Automation)
- 2 Workstation for measuring device operation: with Custom Add-On Profile for "RSLogix 5000" (Rockwell Automation) or with Electronic Data Sheet (EDS)
- 3 Computer with Web browser (e.g. Internet Explorer) for accessing the integrated device Web server or computer with operating tool (e.g. FieldCare, DeviceCare) with COM DTM "CDI Communication TCP/IP"
- 4 Ethernet switch
- 5 Measuring device

**Via PROFINET network**

This communication interface is available in device versions with PROFINET.

*Star topology*

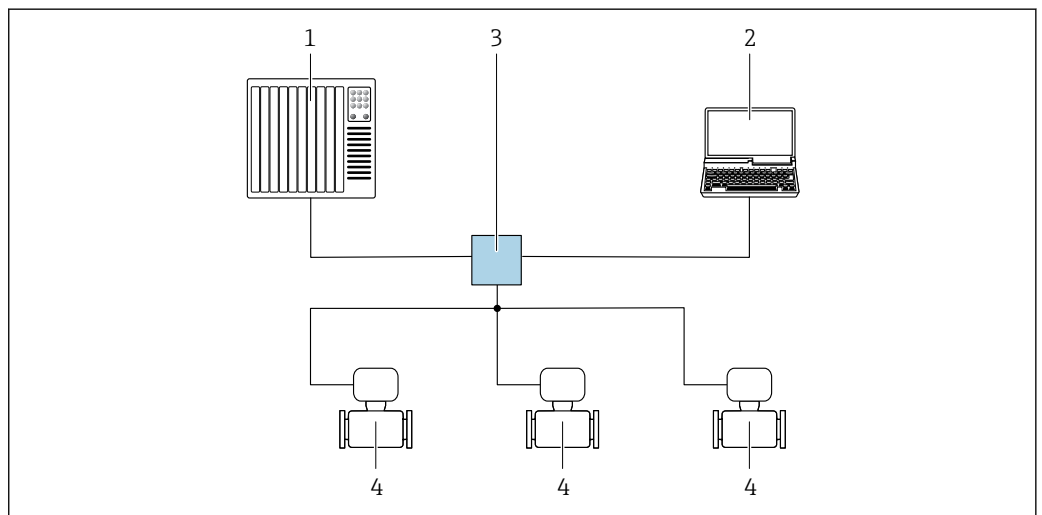

A0026545

55 Options for remote operation via PROFINET network: star topology

- 1 Automation system, e.g. Simatic S7 (Siemens)
- 2 Computer with Web browser (e.g. Internet Explorer) for accessing the integrated device Web server or computer with operating tool (e.g. FieldCare, DeviceCare, SIMATIC PDM) with COM DTM "CDI Communication TCP/IP"
- 3 Switch, e.g. Scalance X204 (Siemens)
- 4 Measuring device

*Ring topology*

The device is integrated via the terminal connection for signal transmission (output 1) and the service interface (CDI-RJ45).

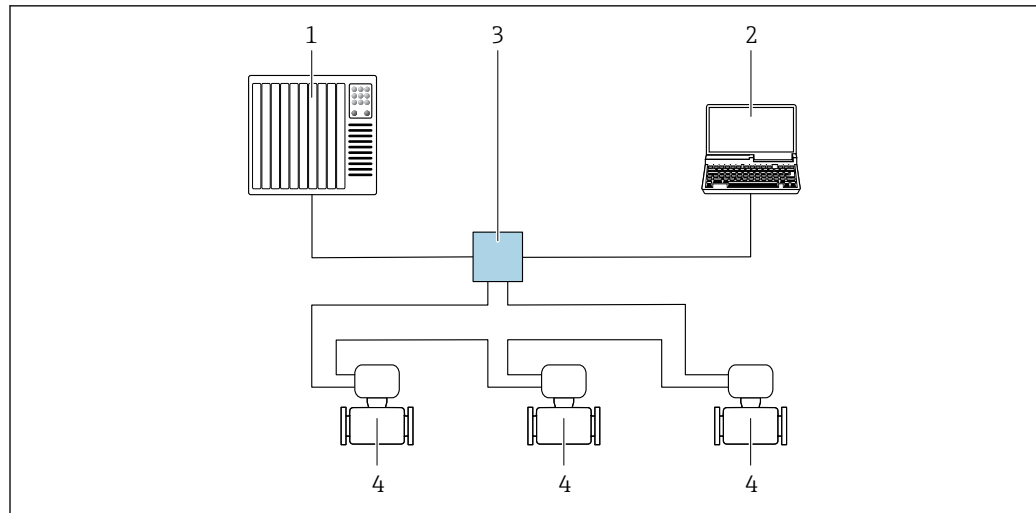

A0033719

56 Options for remote operation via PROFINET network: ring topology

- 1 Automation system, e.g. Simatic S7 (Siemens)
- 2 Computer with Web browser (e.g. Internet Explorer) for accessing the integrated device Web server or computer with operating tool (e.g. FieldCare, DeviceCare, SIMATIC PDM) with COM DTM "CDI Communication TCP/IP"
- 3 Switch, e.g. Scalance X204 (Siemens)
- 4 Measuring device

## Service interface

### Via service interface (CDI-RJ45)

A point-to-point connection can be established to configure the device onsite. With the housing open, the connection is established directly via the service interface (CDI-RJ45) of the device.

**i** An adapter for RJ45 and the M12 connector is optionally available:  
Order code for "Accessories", option **NB**: "Adapter RJ45 M12 (service interface)"

The adapter connects the service interface (CDI-RJ45) to an M12 connector mounted in the cable entry. Therefore the connection to the service interface can be established via an M12 connector without opening the device.

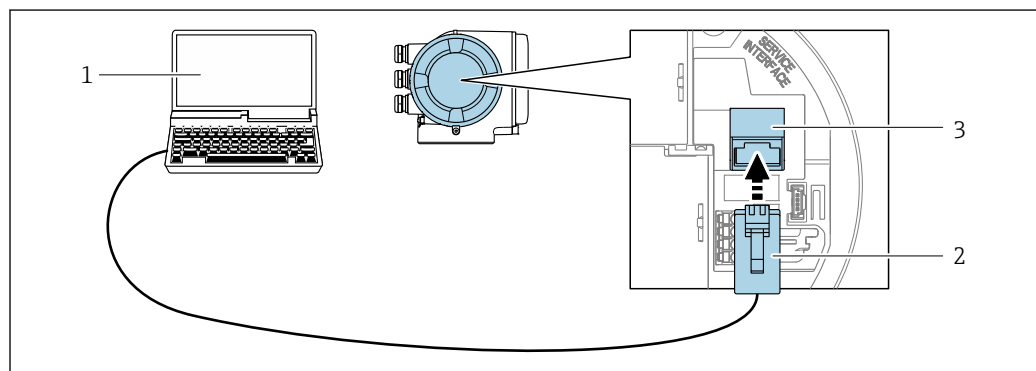

A0027563

57 Connection via service interface (CDI-RJ45)

- 1 Computer with Web browser (e.g. Microsoft Internet Explorer, Microsoft Edge) for accessing the integrated device Web server or with "FieldCare", "DeviceCare" operating tool with COM DTM "CDI Communication TCP/IP" or Modbus DTM
- 2 Standard Ethernet connecting cable with RJ45 connector
- 3 Service interface (CDI-RJ45) of the measuring device with access to the integrated Web server

### Via WLAN interface

The optional WLAN interface is available on the following device version:

Order code for "Display; operation", option G "4-line, illuminated; touch control + WLAN"

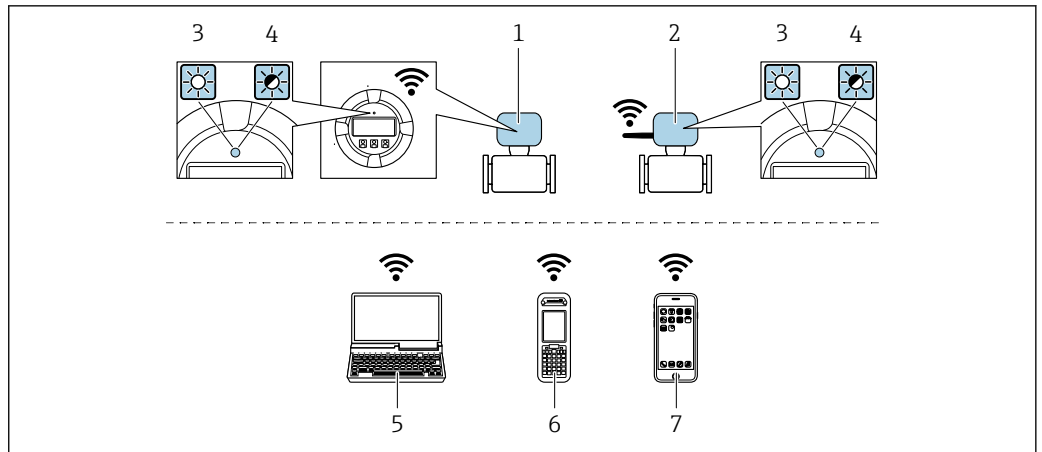

A0034570

- 1 Transmitter with integrated WLAN antenna
- 2 Transmitter with external WLAN antenna
- 3 LED lit constantly: WLAN reception is enabled on measuring device
- 4 LED flashing: WLAN connection established between operating unit and measuring device
- 5 Computer with WLAN interface and Web browser (e.g. Microsoft Internet Explorer, Microsoft Edge) for accessing the integrated device Web server or with operating tool (e.g. FieldCare, DeviceCare)
- 6 Mobile handheld terminal with WLAN interface and Web browser (e.g. Microsoft Internet Explorer, Microsoft Edge) for accessing the integrated device Web server or operating tool (e.g. FieldCare, DeviceCare)
- 7 Smart phone or tablet (e.g. Field Xpert SMT70)

Function	WLAN: IEEE 802.11 b/g (2.4 GHz) <ul style="list-style-type: none"> <li>▪ Access point with DHCP server (default setting)</li> <li>▪ Network</li> </ul>
Encryption	WPA2-PSK AES-128 (in accordance with IEEE 802.11i)
Configurable WLAN channels	1 to 11
Degree of protection	IP67
Available antennas	<ul style="list-style-type: none"> <li>▪ Internal antenna</li> <li>▪ External antenna (optional)</li> </ul> In the event of poor transmission/reception conditions at the place of installation. Available as an accessory → 96.
Range	<ul style="list-style-type: none"> <li>▪ Internal antenna: typically 10 m (32 ft)</li> <li>▪ External antenna: typically 50 m (164 ft)</li> </ul>
Materials (external antenna)	<ul style="list-style-type: none"> <li>▪ Antenna: ASA plastic (acrylic ester-styrene-acrylonitrile) and nickel-plated brass</li> <li>▪ Adapter: Stainless steel and nickel-plated brass</li> <li>▪ Cable: Polyethylene</li> <li>▪ Connector: Nickel-plated brass</li> <li>▪ Angle bracket: Stainless steel</li> </ul>

**Network integration**

With the optional "OPC-UA Server" application package, the device can be integrated into an Ethernet network via the service interface (CDI-RJ45 and WLAN) and communicate with OPC-UA clients. If the device is used in this way, IT security must be considered.

**i** Transmitters with an Ex de approval may **not** be connected via the service interface (CDI-RJ45)!  
 Order code for "Approval transmitter + sensor", options (Ex de):  
 BA, BB, C1, C2, GA, GB, MA, MB, NA, NB

For permanent access to device data and for device configuration via the Web server, the device is incorporated directly in a network via the service interface (CDI-RJ45). In this way, the device can be accessed any time from the control station. The measured values are processed separately via the inputs and outputs through the automation system.

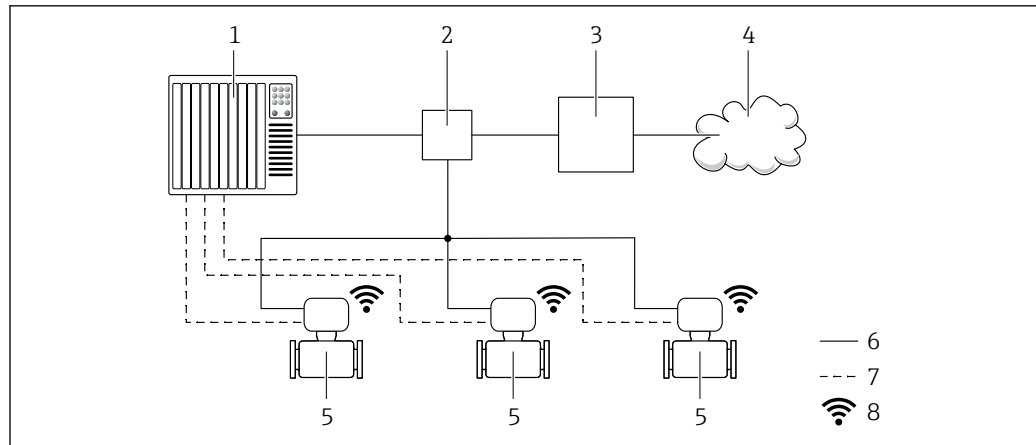

A0033618

- 1 Automation system, e.g. Simatic S7 (Siemens)
- 2 Ethernet switch
- 3 Edge Gateway
- 4 Cloud
- 5 Measuring device
- 6 Ethernet network
- 7 Measured values via inputs and outputs
- 8 Optional WLAN interface



The optional WLAN interface is available on the following device version:

Order code for "Display; operation", option **G** "4-line, illuminated, graphic display; touch control + WLAN"





Special Documentation for the OPC-UA Server application package → 101.

### Supported operating tools

Different operating tools can be used for local or remote access to the measuring device. Depending on the operating tool used, access is possible with different operating units and via a variety of interfaces.

Supported operating tools	Operating unit	Interface	Additional information
Web browser	Notebook, PC or tablet with Web browser	<ul style="list-style-type: none"> <li>▪ CDI-RJ45 service interface</li> <li>▪ WLAN interface</li> <li>▪ Ethernet-based fieldbus (EtherNet/IP, PROFINET)</li> </ul>	Special Documentation for device → 101
DeviceCare SFE100	Notebook, PC or tablet with Microsoft Windows system	<ul style="list-style-type: none"> <li>▪ CDI-RJ45 service interface</li> <li>▪ WLAN interface</li> <li>▪ Fieldbus protocol</li> </ul>	→ 98

Supported operating tools	Operating unit	Interface	Additional information
FieldCare SFE500	Notebook, PC or tablet with Microsoft Windows system	<ul style="list-style-type: none"> <li>■ CDI-RJ45 service interface</li> <li>■ WLAN interface</li> <li>■ Fieldbus protocol</li> </ul>	→  98
Device Xpert	Field Xpert SFX 100/350/370	HART and FOUNDATION Fieldbus fieldbus protocol	Operating Instructions BA01202S Device description files: Use update function of handheld terminal

 Other operating tools based on FDT technology with a device driver such as DTM/iDTM or DD/EDD can be used for device operation. These operating tools are available from the individual manufacturers. Integration into the following operating tools, among others, is supported:

- FactoryTalk AssetCentre (FTAC) by Rockwell Automation → [www.rockwellautomation.com](http://www.rockwellautomation.com)
- Process Device Manager (PDM) by Siemens → [www.siemens.com](http://www.siemens.com)
- Asset Management Solutions (AMS) by Emerson → [www.emersonprocess.com](http://www.emersonprocess.com)
- FieldCommunicator 375/475 by Emerson → [www.emersonprocess.com](http://www.emersonprocess.com)
- Field Device Manager (FDM) by Honeywell → [www.honeywellprocess.com](http://www.honeywellprocess.com)
- FieldMate by Yokogawa → [www.yokogawa.com](http://www.yokogawa.com)
- PACTWare → [www.pactware.com](http://www.pactware.com)

The associated device description files are available at: [www.endress.com](http://www.endress.com) → Downloads

### Web server



Thanks to the integrated Web server, the device can be operated and configured via a Web browser and via a service interface (CDI-RJ45) or via a WLAN interface. The structure of the operating menu is the same as for the local display. In addition to the measured values, status information on the device is also displayed and allows the user to monitor the status of the device. Furthermore the device data can be managed and the network parameters can be configured.

A device that has a WLAN interface (can be ordered as an option) is required for the WLAN connection: order code for "Display; operation", option G "4-line, illuminated; touch control + WLAN". The device acts as an Access Point and enables communication by computer or a mobile handheld terminal.

### Supported functions

Data exchange between the operating unit (such as a notebook for example) and the measuring device:

- Upload the configuration from the measuring device (XML format, configuration backup)
- Save the configuration to the measuring device (XML format, restore configuration)
- Export event list (.csv file)
- Export parameter settings (.csv file or PDF file, document the measuring point configuration)
- Export the Heartbeat verification log (PDF file, only available with the "Heartbeat Verification" application package)
- Flash firmware version for device firmware upgrade, for instance
- Download driver for system integration
- Visualize up to 1000 saved measured values (only available with the **Extended HistoROM** application package →  95)

 Web server special documentation →  101

### HistoROM data management

The measuring device features HistoROM data management. HistoROM data management comprises both the storage and import/export of key device and process data, making operation and servicing far more reliable, secure and efficient.

 When the device is delivered, the factory settings of the configuration data are stored as a backup in the device memory. This memory can be overwritten with an updated data record, for example after commissioning.

### Additional information on the data storage concept

There are different types of data storage units in which device data are stored and used by the device:

	Device memory	T-DAT	S-DAT
<b>Available data</b>	<ul style="list-style-type: none"> <li>▪ Event logbook such as diagnostic events for example</li> <li>▪ Parameter data record backup</li> <li>▪ Device firmware package</li> <li>▪ Driver for system integration for exporting via Web server, e.g.:               <ul style="list-style-type: none"> <li>▪ GSD for PROFIBUS DP</li> <li>▪ GSD for PROFIBUS PA</li> <li>▪ GSDML for PROFINET</li> <li>▪ EDS for EtherNet/IP</li> <li>▪ DD for FOUNDATION Fieldbus</li> </ul> </li> </ul>	<ul style="list-style-type: none"> <li>▪ Measured value logging ("Extended HistoROM" order option)</li> <li>▪ Current parameter data record (used by firmware at run time)</li> <li>▪ Peakhold indicator (min/max values)</li> <li>▪ Totalizer values</li> </ul>	<ul style="list-style-type: none"> <li>▪ Sensor data: nominal diameter etc.</li> <li>▪ Serial number</li> <li>▪ Calibration data</li> <li>▪ Device configuration (e.g. SW options, fixed I/O or multi I/O)</li> </ul>
<b>Storage location</b>	Fixed on the user interface board in the connection compartment	Attachable to the user interface board in the connection compartment	In the sensor plug in the transmitter neck part

#### Data backup

##### Automatic

- The most important device data (sensor and transmitter) are automatically saved in the DAT modules
- If the transmitter or measuring device is replaced: once the T-DAT containing the previous device data has been exchanged, the new measuring device is ready for operation again immediately without any errors
- If the sensor is replaced: once the sensor has been replaced, new sensor data are transferred from the S-DAT in the measuring device and the measuring device is ready for operation again immediately without any errors
- If exchanging the electronics module (e.g. I/O electronics module): Once the electronics module has been replaced, the software of the module is compared against the current device firmware. The module software is upgraded or downgraded where necessary. The electronics module is available for use immediately afterwards and no compatibility problems occur.

##### Manual

Additional parameter data record (complete parameter settings) in the integrated device memory HistoROM backup for:

- Data backup function  
Backup and subsequent restoration of a device configuration in the device memory HistoROM backup
- Data comparison function  
Comparison of the current device configuration with the device configuration saved in the device memory HistoROM backup

#### Data transfer

##### Manual

- Transfer of a device configuration to another device using the export function of the specific operating tool, e.g. with FieldCare, DeviceCare or Web server: to duplicate the configuration or to store in an archive (e.g. for backup purposes)
- Transmission of the drivers for system integration via Web server, e.g.:
  - GSD for PROFIBUS DP
  - GSD for PROFIBUS PA
  - GSDML for PROFINET
  - EDS for EtherNet/IP
  - DD for FOUNDATION Fieldbus

#### Event list

##### Automatic

- Chronological display of up to 20 event messages in the events list
- If the **Extended HistoROM** application package (order option) is enabled: up to 100 event messages are displayed in the events list along with a time stamp, plain text description and remedial measures
- The events list can be exported and displayed via a variety of interfaces and operating tools e.g. DeviceCare, FieldCare or Web server

**Data logging**

**Manual**

If the **Extended HistoROM** application package (order option) is enabled:

- Record up to 1 000 measured values via 1 to 4 channels
- User configurable recording interval
- Record up to 250 measured values via each of the 4 memory channels
- Export the measured value log via a variety of interfaces and operating tools e.g. FieldCare, DeviceCare or web server

## Certificates and approvals

 Currently available certificates and approvals can be called up via the product configurator.

**CE mark**

The device meets the legal requirements of the applicable EU Directives. These are listed in the corresponding EU Declaration of Conformity along with the standards applied.

Endress+Hauser confirms successful testing of the device by affixing to it the CE mark.

**RCM-tick symbol**

The measuring system meets the EMC requirements of the "Australian Communications and Media Authority (ACMA)".

**Ex approval**

The measuring device is certified for use in hazardous areas and the relevant safety instructions are provided in the separate "Safety Instructions" (XA) document. Reference is made to this document on the nameplate.

Devices with the order code for "Approval; transmitter + sensor", option BA, BB, BC or BD have equipment protection level (EPL) Ga/Gb (Zone 0 in the measuring tube).

 The separate Ex documentation (XA) containing all the relevant explosion protection data is available from your Endress+Hauser sales center.

**ATEX/IECEx**

Currently, the following versions for use in hazardous areas are available:

*Ex db eb*

Category	Type of protection
II1/2G	Ex db eb ia IIC T6...T1 Ga/Gb Ex db eb ia IIB T6...T1 Ga/Gb
II2G	Ex db eb ia IIC T6...T1 Gb Ex db eb ia IIB T6...T1 Gb

*Ex db*

Category	Type of protection
II1/2G	Ex db ia IIC T6...T1 Ga/Gb Ex db ia IIB T6...T1 Ga/Gb
II2G	Ex db ia IIC T6...T1 Gb Ex db ia IIB T6...T1 Gb

*Ex ec*

Category	Type of protection
II3G	Ex ec IIC T5...T1 Gc

Ex tb

Category	Type of protection
II2D	Ex tb IIIC T** °C Db

cCSA<sub>US</sub>

Currently, the following versions for use in hazardous areas are available:

**IS (Ex i) and XP (Ex d)**

- Class I, III, III Division 1 Groups A-G
- Class I, III, III Division 1 Groups C-G

**NI (Ex nA)**

Class I Division 2 Groups A - D

**Ex de**

- Class I, Zone 1 AEx/ Ex de ia IIC T6...T1 Ga/Gb  
Class I, Zone 1 AEx/ Ex de ia IIB T6...T1 Ga/Gb
- Class I, Zone 1 AEx/ Ex de ia IIC T6...T1 Gb  
Class I, Zone 1 AEx/ Ex de ia IIB T6...T1 Gb

**Ex d**

- Class I, Zone 1 AEx/ Ex d ia IIC T6...T1 Ga/Gb  
Class I, Zone 1 AEx/ Ex d ia IIB T6...T1 Ga/Gb
- Class I, Zone 1 AEx/ Ex d ia IIC T6...T1 Gb  
Class I, Zone 1 AEx/ Ex d ia IIB T6...T1 Gb

**Ex nA**

Class I, Zone 2 AEx/ Ex nA IIC T5...T1 Gc

**Ex tb**

Zone 21 AEx/ Ex tb IIIC T\*\* °C Db

**Sanitary compatibility**

- 3-A approval
  - Only measuring devices with the order code for "Additional approval", option LP "3A" have 3-A approval.
  - The 3-A approval refers to the measuring device.
  - When installing the measuring device, ensure that no liquid can accumulate on the outside of the measuring device.  
Remote transmitters must be installed in accordance with the 3-A Standard.
  - Accessories (e.g. heating jacket, weather protection cover, wall holder unit) must be installed in accordance with the 3-A Standard.  
Each accessory can be cleaned. Disassembly may be necessary under certain circumstances.
- EHEDG-tested  
Only devices with the order code for "Additional approval", option LT "EHEDG" have been tested and meet the requirements of the EHEDG.  
To meet the requirements for EHEDG certification, the device must be used with process connections in accordance with the EHEDG position paper entitled "Easy Cleanable Pipe Couplings and Process Connections" ([www.ehedg.org](http://www.ehedg.org)).
- FDA
- Food Contact Materials Regulation (EC) 1935/2004

**Pharmaceutical compatibility**

- FDA
- USP Class VI
- TSE/BSE Certificate of Suitability
- cGMP
-  Devices with the order code "Test, Certificate", option JG "Conformity to cGMP derived requirements, declaration" meet the requirements of cGMP in regards of wetted parts surface finish, design, FDA 21 CFR material compliance, USP Class VI testing, and TSE/BSE compliance.  
A serial number specific manufacturers declaration is delivered with the device.



**Functional safety**

The measuring device can be used for flow monitoring systems (min., max., range) up to SIL 2 (single-channel architecture; order code for "Additional approval", option LA) and SIL 3 (multichannel architecture with homogeneous redundancy) and is independently evaluated and certified by the TÜV in accordance with IEC 61508.



The following types of monitoring in safety equipment are possible:

- Mass flow
- Volume flow
- Density

 Functional Safety Manual with information on the SIL device →  100

---

#### HART certification

#### HART interface

The measuring device is certified and registered by the FieldComm Group. The measuring system meets all the requirements of the following specifications:

- Certified according to HART 7
- The device can also be operated with certified devices of other manufacturers (interoperability)

---

#### FOUNDATION Fieldbus certification

#### FOUNDATION Fieldbus interface

The measuring device is certified and registered by the FieldComm Group. The measuring system meets all the requirements of the following specifications:

- Certified in accordance with FOUNDATION Fieldbus H1
- Interoperability Test Kit (ITK), revision version 6.2.0 (certificate available on request)
- Physical Layer Conformance Test
- The device can also be operated with certified devices of other manufacturers (interoperability)

---

#### Certification PROFIBUS

#### PROFIBUS interface

The measuring device is certified and registered by the PNO (PROFIBUS User Organization). The measuring system meets all the requirements of the following specifications:

- Certified in accordance with PROFIBUS PA Profile 3.02
- The device can also be operated with certified devices of other manufacturers (interoperability)

---

#### EtherNet/IP certification

The measuring device is certified and registered by the ODVA (Open Device Vendor Association). The measuring system meets all the requirements of the following specifications:

- Certified in accordance with the ODVA Conformance Test
- EtherNet/IP Performance Test
- EtherNet/IP PlugFest compliance
- The device can also be operated with certified devices of other manufacturers (interoperability)

---

#### Certification PROFINET

#### PROFINET interface

The measuring device is certified and registered by the PNO (PROFIBUS User Organization). The measuring system meets all the requirements of the following specifications:

- Certified according to:
  - Test specification for PROFINET devices
  - PROFINET Security Level 2 – Netload Class
- The device can also be operated with certified devices of other manufacturers (interoperability)
- The device supports PROFINET S2 system redundancy.

---

#### Pressure Equipment Directive

The devices can be ordered with or without a PED approval. If a device with a PED approval is required, this must be explicitly stated in the order. For devices with nominal diameters less than or equal to DN 25 (1"), this is neither possible nor necessary.

- With the identification PED/G1/x (x = category) on the sensor nameplate, Endress+Hauser confirms conformity with the "Essential Safety Requirements" specified in Appendix I of the Pressure Equipment Directive 2014/68/EU.
- Devices bearing this marking (PED) are suitable for the following types of medium:
  - Media in Group 1 and 2 with a vapor pressure greater than, or smaller and equal to 0.5 bar (7.3 psi)
  - Unstable gases
- Devices not bearing this marking (PED) are designed and manufactured according to good engineering practice. They meet the requirements of Article 4 paragraph 3 of the Pressure Equipment Directive 2014/68/EU. The range of application is indicated in tables 6 to 9 in Annex II of the Pressure Equipment Directive 2014/68/EU.

**Radio approval**

The measuring device has radio approval.



For detailed information regarding radio approval, see Special Documentation → 101

**Additional certification****CRN approval**

Some device versions have CRN approval. A CRN-approved process connection with a CSA approval must be ordered for a CRN-approved device.

**Tests and certificates**

- EN10204-3.1 material certificate, parts and sensor housing in contact with medium
- Pressure testing, internal procedure, inspection certificate
- PMI test (XRF), internal procedure, wetted parts, test report
- EN10204-2.1 confirmation of compliance with the order and EN10204-2.2 test report

**Other standards and guidelines**

- EN 60529  
Degrees of protection provided by enclosures (IP code)
- IEC/EN 60068-2-6  
Environmental influences: Test procedure - Test Fc: vibrate (sinusoidal).
- IEC/EN 60068-2-31  
Environmental influences: Test procedure - Test Ec: shocks due to rough handling, primarily for devices.
- EN 61010-1  
Safety requirements for electrical equipment for measurement, control and laboratory use - general requirements
- IEC/EN 61326  
Emission in accordance with Class A requirements. Electromagnetic compatibility (EMC requirements).
- NAMUR NE 21  
Electromagnetic compatibility (EMC) of industrial process and laboratory control equipment
- NAMUR NE 32  
Data retention in the event of a power failure in field and control instruments with microprocessors
- NAMUR NE 43  
Standardization of the signal level for the breakdown information of digital transmitters with analog output signal.
- NAMUR NE 53  
Software of field devices and signal-processing devices with digital electronics
- NAMUR NE 80  
The application of the pressure equipment directive to process control devices
- NAMUR NE 105  
Specifications for integrating fieldbus devices in engineering tools for field devices
- NAMUR NE 107  
Self-monitoring and diagnosis of field devices
- NAMUR NE 131  
Requirements for field devices for standard applications
- NAMUR NE 132  
Coriolis mass meter
- ETSI EN 300 328  
Guidelines for 2.4 GHz radio components.
- EN 301489  
Electromagnetic compatibility and radio spectrum matters (ERM).

## Ordering information

Detailed ordering information is available for your nearest sales organization [www.addresses.endress.com](http://www.addresses.endress.com) or in the Product Configurator under [www.endress.com](http://www.endress.com) :

1. Click Corporate
2. Select the country
3. Click Products

4. Select the product using the filters and search field
5. Open the product page

The Configuration button to the right of the product image opens the Product Configurator.



**Product Configurator - the tool for individual product configuration**

- Up-to-the-minute configuration data
- Depending on the device: Direct input of measuring point-specific information such as measuring range or operating language
- Automatic verification of exclusion criteria
- Automatic creation of the order code and its breakdown in PDF or Excel output format
- Ability to order directly in the Endress+Hauser Online Shop

## Application packages

Many different application packages are available to enhance the functionality of the device. Such packages might be needed to address safety aspects or specific application requirements.

The application packages can be ordered with the device or subsequently from Endress+Hauser. Detailed information on the order code in question is available from your local Endress+Hauser sales center or on the product page of the Endress+Hauser website: [www.endress.com](http://www.endress.com).



Detailed information on the application packages:  
Special Documentation for the device → 100

### Diagnostics functions



Package	Description
Extended HistoROM	<p>Comprises extended functions concerning the event log and the activation of the measured value memory.</p> <p>Event log: Memory volume is extended from 20 message entries (standard version) to up to 100 entries.</p> <p>Data logging (line recorder):</p> <ul style="list-style-type: none"> <li>▪ Memory capacity for up to 1000 measured values is activated.</li> <li>▪ 250 measured values can be output via each of the 4 memory channels. The recording interval can be defined and configured by the user.</li> <li>▪ Measured value logs can be accessed via the local display or operating tool e.g. FieldCare, DeviceCare or Web server.</li> </ul>

### Heartbeat Technology

Package	Description
Heartbeat Verification +Monitoring	<p><b>Heartbeat Verification</b> Meets the requirement for traceable verification to DIN ISO 9001:2008 Chapter 7.6 a) "Control of monitoring and measuring equipment".</p> <ul style="list-style-type: none"> <li>▪ Functional testing in the installed state without interrupting the process.</li> <li>▪ Traceable verification results on request, including a report.</li> <li>▪ Simple testing process via local operation or other operating interfaces.</li> <li>▪ Clear measuring point assessment (pass/fail) with high test coverage within the framework of manufacturer specifications.</li> <li>▪ Extension of calibration intervals according to operator's risk assessment.</li> </ul> <p><b>Heartbeat Monitoring</b> Continuously supplies data, which are characteristic of the measuring principle, to an external condition monitoring system for the purpose of preventive maintenance or process analysis. These data enable the operator to:</p> <ul style="list-style-type: none"> <li>▪ Draw conclusions - using these data and other information - about the impact process influences (such as corrosion, abrasion, buildup etc.) have on the measuring performance over time.</li> <li>▪ Schedule servicing in time.</li> <li>▪ Monitor the process or product quality, e.g. gas pockets.</li> </ul>

Concentration	Package	Description
	Concentration	<p><b>Calculation and outputting of fluid concentrations</b></p> <p>The measured density is converted to the concentration of a substance of a binary mixture using the "Concentration" application package:</p> <ul style="list-style-type: none"> <li>▪ Choice of predefined fluids (e.g. various sugar solutions, acids, alkalis, salts, ethanol etc.)</li> <li>▪ Common or user-defined units (°Brix, °Plato, % mass, % volume, mol/l etc.) for standard applications.</li> <li>▪ Concentration calculation from user-defined tables.</li> </ul>

Special density	Package	Description
	Special density	<p>Many applications use density as a key measured value for monitoring quality or controlling processes. The device measures the density of the fluid as standard and makes this value available to the control system.</p> <p>The "Special Density" application package offers high-precision density measurement over a wide density and temperature range particularly for applications subject to varying process conditions.</p>



OPC-UA server	Package	Description
	OPC-UA-Server	<p>The application package provides the user with an integrated OPC-UA server for comprehensive instrument services for IoT and SCADA applications.</p> <p> Special Documentation for the "OPC-UA-Server" application package →  101.</p>









## Accessories

Various accessories, which can be ordered with the device or subsequently from Endress+Hauser, are available for the device. Detailed information on the order code in question is available from your local Endress+Hauser sales center or on the product page of the Endress+Hauser website: [www.endress.com](http://www.endress.com).



### Device-specific accessories

#### For the transmitter

Accessories	Description
Proline 300 transmitter	<p>Transmitter for replacement or storage. Use the order code to define the following specifications:</p> <ul style="list-style-type: none"> <li>▪ Approvals</li> <li>▪ Output</li> <li>▪ Input</li> <li>▪ Display/operation</li> <li>▪ Housing</li> <li>▪ Software</li> </ul> <p> Order code: 8X3BXX</p> <p> Installation Instructions EA01263D</p>











<p>Remote display and operating module DKX001</p>	<ul style="list-style-type: none"> <li>▪ If ordered directly with the measuring device: Order code for "Display; operation", option O "Remote display 4-line illum.; 10 m (30 ft) Cable; touch control"</li> <li>▪ If ordered separately:             <ul style="list-style-type: none"> <li>▪ Measuring device: order code for "Display; operation", option M "W/o, prepared for remote display"</li> <li>▪ DKX001: Via the separate product structure DKX001</li> </ul> </li> <li>▪ If ordered subsequently: DKX001: Via the separate product structure DKX001</li> </ul> <p><b>Mounting bracket for DKX001</b></p> <ul style="list-style-type: none"> <li>▪ If ordered directly: order code for "Accessory enclosed", option RA "Mounting bracket, pipe 1 1/2"</li> <li>▪ If ordered subsequently: order number: 71340960</li> </ul> <p><b>Connecting cable (replacement cable)</b> Via the separate product structure: DKX002</p> <p> Further information on display and operating module DKX001 →  80.</p> <p> Special Documentation SD01763D</p>
<p>External WLAN antenna</p>	<p>External WLAN antenna with 1.5 m (59.1 in) connecting cable and two angle brackets. Order code for "Accessory enclosed", option P8 "Wireless antenna wide area".</p> <p> <ul style="list-style-type: none"> <li>▪ The external WLAN antenna is not suitable for use in hygienic applications.</li> <li>▪ Further information on the WLAN interface →  86.</li> </ul></p> <p> Order number: 71351317</p> <p> Installation Instructions EA01238D</p>
<p>Protective cover</p>	<p>Is used to protect the measuring device from the effects of the weather: e.g. rainwater, excess heating from direct sunlight.</p> <p> Order number: 71343505</p> <p> Installation Instructions EA01160D</p>

**For the sensor**

Accessories	Description
<p>Heating jacket</p>	<p>Is used to stabilize the temperature of the fluids in the sensor. Water, water vapor and other non-corrosive liquids are permitted for use as fluids.</p> <p> If using oil as a heating medium, please consult with Endress+Hauser.</p> <ul style="list-style-type: none"> <li>▪ If ordered together with the measuring device: order code for "Enclosed accessories"             <ul style="list-style-type: none"> <li>▪ Option RB "heating jacket, G 1/2" internal thread"</li> <li>▪ Option RC "heating jacket, G 3/4" internal thread"</li> <li>▪ Option RD "Heating jacket, NPT 1/2" internal thread"</li> <li>▪ Option RE "Heating jacket, NPT 3/4" internal thread"</li> </ul> </li> <li>▪ If ordered subsequently: Use the order code with the product root DK8003.</li> </ul> <p> Special Documentation SD02162D</p>



**Communication-specific accessories**

Accessories	Description
<p>Commubox FXA195 HART</p>	<p>For intrinsically safe HART communication with FieldCare via the USB interface.</p> <p> Technical Information TI00404F</p>





HART Loop Converter HMX50	<p>Is used to evaluate and convert dynamic HART process variables to analog current signals or limit values.</p> <ul style="list-style-type: none"> <li> Technical Information TI00429F</li> <li> Operating Instructions BA00371F</li> </ul>
Fieldgate FXA320	<p>Gateway for the remote monitoring of connected 4-20 mA measuring devices via a Web browser.</p> <ul style="list-style-type: none"> <li> Technical Information TI00025S</li> <li> Operating Instructions BA00053S</li> </ul>
Fieldgate FXA520	<p>Gateway for the remote diagnostics and remote configuration of connected HART measuring devices via a Web browser.</p> <ul style="list-style-type: none"> <li> Technical Information TI00025S</li> <li> Operating Instructions BA00051S</li> </ul>
Field Xpert SFX350	<p>Field Xpert SFX350 is a mobile computer for commissioning and maintenance. It enables efficient device configuration and diagnostics for HART and FOUNDATION Fieldbus devices and can be used in non-hazardous areas.</p> <ul style="list-style-type: none"> <li> Operating Instructions BA01202S</li> </ul>
Field Xpert SFX370	<p>Field Xpert SFX370 is a mobile computer for commissioning and maintenance. It enables efficient device configuration and diagnostics for HART and FOUNDATION Fieldbus devices and can be used in the non-hazardous area and in the hazardous area.</p> <ul style="list-style-type: none"> <li> Operating Instructions BA01202S</li> </ul>
Field Xpert SMT70	<p>The Field Xpert SMT70 tablet PC for device configuration enables mobile plant asset management in hazardous and non-hazardous areas. It is suitable for commissioning and maintenance staff to manage field instruments with a digital communication interface and to record progress. This tablet PC is designed as an all-in-one solution with a preinstalled driver library and is an easy-to-use, touch-sensitive tool which can be used to manage field instruments throughout their entire life cycle.</p> <ul style="list-style-type: none"> <li> Technical Information TI01342S</li> <li> Operating Instructions BA01709S</li> <li> Product page: <a href="http://www.endress.com/smt70">www.endress.com/smt70</a></li> </ul>

## Service-specific accessories

Accessories	Description
Applicator	<p>Software for selecting and sizing Endress+Hauser measuring devices:</p> <ul style="list-style-type: none"> <li>▪ Choice of measuring devices for industrial requirements</li> <li>▪ Calculation of all the necessary data for identifying the optimum flowmeter: e.g. nominal diameter, pressure loss, flow velocity and accuracy.</li> <li>▪ Graphic illustration of the calculation results</li> <li>▪ Determination of the partial order code, administration, documentation and access to all project-related data and parameters over the entire life cycle of a project.</li> </ul> <p>Applicator is available:</p> <ul style="list-style-type: none"> <li>▪ Via the Internet: <a href="https://portal.endress.com/webapp/applicator">https://portal.endress.com/webapp/applicator</a></li> <li>▪ As a downloadable DVD for local PC installation.</li> </ul>
W@M	<p>W@M Life Cycle Management</p> <p>Improved productivity with information at your fingertips. Data relevant to a plant and its components is generated from the first stages of planning and during the asset's complete life cycle.</p> <p>W@M Life Cycle Management is an open and flexible information platform with online and on-site tools. Instant access for your staff to current, in-depth data shortens your plant's engineering time, speeds up procurement processes and increases plant uptime.</p> <p>Combined with the right services, W@M Life Cycle Management boosts productivity in every phase. For more information, visit <a href="http://www.endress.com/lifecyclemanagement">www.endress.com/lifecyclemanagement</a></p>

Accessories	Description
FieldCare	FDT-based plant asset management tool from Endress+Hauser. It can configure all smart field units in your system and helps you manage them. By using the status information, it is also a simple but effective way of checking their status and condition.  Operating Instructions BA00027S and BA00059S
DeviceCare	Tool to connect and configure Endress+Hauser field devices.  Innovation brochure IN01047S

**System components**

Accessories	Description
Memograph M graphic data manager	The Memograph M graphic data manager provides information on all the relevant measured variables. Measured values are recorded correctly, limit values are monitored and measuring points analyzed. The data are stored in the 256 MB internal memory and also on a SD card or USB stick.  <ul style="list-style-type: none"> <li>▪ Technical Information TI00133R</li> <li>▪ Operating Instructions BA00247R</li> </ul>
Cerabar M	The pressure transmitter for measuring the absolute and gauge pressure of gases, steam and liquids. It can be used to read in the operating pressure value.  <ul style="list-style-type: none"> <li>▪ Technical Information TI00426P and TI00436P</li> <li>▪ Operating Instructions BA00200P and BA00382P</li> </ul>
Cerabar S	The pressure transmitter for measuring the absolute and gauge pressure of gases, steam and liquids. It can be used to read in the operating pressure value.  <ul style="list-style-type: none"> <li>▪ Technical Information TI00383P</li> <li>▪ Operating Instructions BA00271P</li> </ul>
iTEMP	The temperature transmitters can be used in all applications and are suitable for the measurement of gases, steam and liquids. They can be used to read in the medium temperature.  "Fields of Activity" document FA00006T

## Supplementary documentation

-  For an overview of the scope of the associated Technical Documentation, refer to the following:
  - *W@M Device Viewer* ([www.endress.com/deviceviewer](http://www.endress.com/deviceviewer)): Enter the serial number from nameplate
  - *Endress+Hauser Operations App*: Enter the serial number from the nameplate or scan the 2D matrix code (QR code) on the nameplate

**Standard documentation**

**Brief Operating Instructions**

*Brief Operating Instructions for the sensor*

Measuring device	Documentation code
Proline Promass S	KA01287D

*Brief Operating Instructions for transmitter*

Measuring device	Documentation code						
	HART	FOUNDATION Fieldbus	PROFIBUS PA	PROFIBUS DP	Modbus RS485	EtherNet/IP	PROFINET
Proline 300	KA01309D	KA01229D	KA01227D	KA01386D	KA01311D	KA01339D	KA01341D

### Operating Instructions

Measuring device	Documentation code						
	HART	FOUNDATION Fieldbus	PROFIBUS PA	PROFIBUS DP	Modbus RS485	EtherNet/IP	PROFINET
Promass S 300	BA01491D	BA01524D	BA01513D	BA01863D	BA01502D	BA01734D	BA01745D

### Description of Device Parameters

Measuring device	Documentation code						
	HART	FOUNDATION Fieldbus	PROFIBUS PA	PROFIBUS DP	Modbus RS485	EtherNet/IP	PROFINET
Promass 300	GP01057D	GP01094D	GP01058D	GP01134D	GP01059D	GP01114D	GP01115D

### Device-dependent additional documentation

### Safety instructions

Safety instructions for electrical equipment for hazardous areas.

Contents	Documentation code
ATEX/IECEX Ex d/Ex de	XA01405D
ATEX/IECEX Ex ec	XA01439D
cCSAus XP	XA01373D
cCSAus Ex d/ Ex de	XA01372D
cCSAus Ex nA	XA01507D
INMETRO Ex d/Ex de	XA01468D
INMETRO Ex ec	XA01470D
NEPSI Ex d/Ex de	XA01469D
NEPSI Ex nA	XA01471D
EAC Ex d/Ex de	XA01656D
EAC Ex nA	XA01657D
JPN Ex d	XA01778D

### Remote display and operating module DKX001

Contents	Documentation code
ATEX/IECEX Ex i	XA01494D
ATEX/IECEX Ex ec	XA01498D
cCSAus IS	XA01499D
cCSAus Ex nA	XA01513D
INMETRO Ex i	XA01500D
INMETRO Ex ec	XA01501D
NEPSI Ex i	XA01502D
NEPSI Ex nA	XA01503D



### Special Documentation

Contents	Documentation code
Information on the Pressure Equipment Directive	SD01614D
Functional Safety Manual	SD01727D
Remote display and operating module DKX001	SD01763D
Radio approvals for WLAN interface for A309/A310 display module	SD01793D
OPC-UA Server <sup>1)</sup>	SD02039D

1) This Special Documentation is only available for device versions with a HART output.

Contents	Documentation code						
	HART	FOUNDATION Fieldbus	PROFIBUS PA	PROFIBUS DP	Modbus RS485	PROFINET	EtherNet/IP
Web server	SD01662D	SD01665D	SD01664D	SD02226D	SD01663D	SD01969D	SD01968D
Heartbeat Technology	SD01642D	SD01696D	SD01698D	SD02202D	SD01697D	SD01988D	SD01982
Concentration measurement	SD01644D	SD01706D	SD01708D	SD02212D	SD01707D	SD02005D	SD02004D

### Installation Instructions

Content	Comment
Installation instructions for spare part sets and accessories	Documentation code: specified for each individual accessory → 96.

## Registered trademarks

#### **HART®**

Registered trademark of the FieldComm Group, Austin, Texas, USA

#### **PROFIBUS®**

Registered trademark of the PROFIBUS User Organization, Karlsruhe, Germany

#### **FOUNDATION™ Fieldbus**

Registration-pending trademark of the FieldComm Group, Austin, Texas, USA

#### **Modbus®**

Registered trademark of SCHNEIDER AUTOMATION, INC.

#### **EtherNet/IP™**

Trademark of ODVA, Inc.

#### **PROFINET®**

Registered trademark of the PROFIBUS User Organization, Karlsruhe, Germany

#### **TRI-CLAMP®**

Registered trademark of Ladish & Co., Inc., Kenosha, USA



71505591

[www.addresses.endress.com](http://www.addresses.endress.com)

---