

Technical Information

Proline Promag P 200

Electromagnetic flowmeter



The flowmeter for highest medium temperatures with genuine loop-powered technology

Application

- The measuring principle is virtually independent of pressure, density, temperature and viscosity
- Dedicated for chemical and process applications with corrosive liquids and high medium temperatures

Device properties

- Nominal diameter: max. DN 200 (8")
- All common Ex approvals
- Liner made of PTFE or PFA
- Loop-powered technology
- Robust two-chamber housing
- Plant safety: worldwide approvals (SIL, Haz. area)

Your benefits

- Versatile applications – wide variety of wetted materials
- Energy-saving flow measurement – no pressure loss due to cross-section constriction
- Maintenance-free – no moving parts
- Convenient device wiring – separate connection compartment
- Safe operation – no need to open the device due to display with touch control, background lighting
- Integrated verification – Heartbeat Technology™







Table of contents

| | | | |
|---|-----------|--|-----------|
| Document information | 3 | Process | 31 |
| Symbols used | 3 | Medium temperature range | 31 |
| Function and system design | 3 | Conductivity | 31 |
| Measuring principle | 3 | Pressure-temperature ratings | 31 |
| Measuring system | 5 | Pressure tightness | 33 |
| Safety | 5 | Flow limit | 34 |
| Input | 5 | Pressure loss | 34 |
| Measured variable | 5 | System pressure | 34 |
| Measuring range | 5 | Vibrations | 34 |
| Operable flow range | 6 | Mechanical construction | 35 |
| Output | 7 | Dimensions in SI units | 35 |
| Output signal | 7 | Dimensions in US units | 36 |
| Signal on alarm | 8 | Weight | 38 |
| Load | 9 | Measuring tube specification | 38 |
| Ex connection data | 10 | Materials | 39 |
| Low flow cut off | 13 | Fitted electrodes | 40 |
| Galvanic isolation | 13 | Process connections | 40 |
| Protocol-specific data | 13 | Surface roughness | 40 |
| Power supply | 17 | Operability | 41 |
| Terminal assignment | 17 | Operating concept | 41 |
| Pin assignment, device plug | 18 | Local operation | 41 |
| Supply voltage | 18 | Remote operation | 42 |
| Power consumption | 19 | Service interface | 44 |
| Current consumption | 19 | Certificates and approvals | 45 |
| Power supply failure | 19 | CE mark | 45 |
| Electrical connection | 20 | C-Tick symbol | 45 |
| Potential equalization | 23 | Ex approval | 45 |
| Terminals | 24 | Functional safety | 46 |
| Cable entries | 24 | HART certification | 46 |
| Cable specification | 24 | FOUNDATION Fieldbus certification | 46 |
| Overvoltage protection | 25 | Certification PROFIBUS | 46 |
| Performance characteristics | 25 | Other standards and guidelines | 46 |
| Reference operating conditions | 25 | Ordering information | 47 |
| Maximum measured error | 26 | Application packages | 47 |
| Repeatability | 26 | Diagnostics functions | 47 |
| Influence of ambient temperature | 26 | Heartbeat Technology | 47 |
| Installation | 27 | Accessories | 48 |
| Mounting location | 27 | Device-specific accessories | 48 |
| Orientation | 28 | Communication-specific accessories | 49 |
| Inlet and outlet runs | 28 | Service-specific accessories | 49 |
| Adapters | 28 | System components | 50 |
| Special mounting instructions | 29 | Documentation | 50 |
| Environment | 29 | Standard documentation | 50 |
| Ambient temperature range | 29 | Supplementary device-dependent documentation | 51 |
| Storage temperature | 30 | Registered trademarks | 51 |
| Degree of protection | 30 | | |
| Shock resistance | 30 | | |
| Vibration resistance | 30 | | |
| Mechanical load | 30 | | |
| Electromagnetic compatibility (EMC) | 30 | | |









Document information

Symbols used





Electrical symbols

| Symbol | Meaning | Symbol | Meaning |
|---|--|---|--|
|  | Direct current |  | Alternating current |
|  | Direct current and alternating current |  | Ground connection A grounded terminal which, as far as the operator is concerned, is grounded via a grounding system. |
|  | Protective ground connection A terminal which must be connected to ground prior to establishing any other connections. |  | Equipotential connection A connection that has to be connected to the plant grounding system: This may be a potential equalization line or a star grounding system depending on national or company codes of practice. |

Symbols for certain types of information

| Symbol | Meaning |
|---|--|
|  | Permitted Procedures, processes or actions that are permitted. |
|  | Preferred Procedures, processes or actions that are preferred. |
|  | Forbidden Procedures, processes or actions that are forbidden. |
|  | Tip Indicates additional information. |
|  | Reference to documentation |
|  | Reference to page |
|  | Reference to graphic |
|  | Visual inspection |

Symbols in graphics

| Symbol | Meaning | Symbol | Meaning |
|---|----------------|---|--------------------------------|
| 1, 2, 3,... | Item numbers |  | Series of steps |
| A, B, C, ... | Views | A-A, B-B, C-C, ... | Sections |
|  | Hazardous area |  | Safe area (non-hazardous area) |
|  | Flow direction | | |

Function and system design

Measuring principle

Following *Faraday's law of magnetic induction*, a voltage is induced in a conductor moving through a magnetic field.

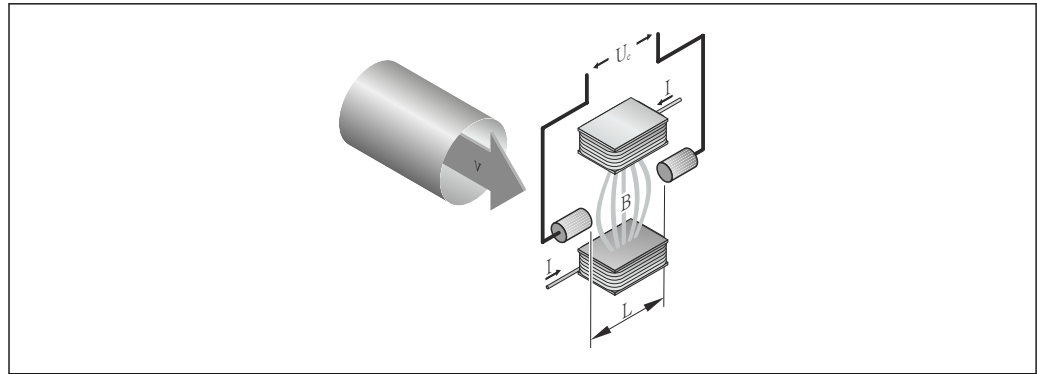

U_e Induced voltage
 B Magnetic induction (magnetic field)
 L Electrode spacing
 I Current
 v Flow velocity

In the electromagnetic measuring principle, the flowing medium is the moving conductor. The voltage induced (U_e) is proportional to the flow velocity (v) and is supplied to the amplifier by means of two measuring electrodes. The flow volume (Q) is calculated via the pipe cross-section (A). The DC magnetic field is created through a switched direct current of alternating polarity.

Formulae for calculation

- Induced voltage $U_e = B \cdot L \cdot v$
- Volume flow $Q = A \cdot v$

Measuring system

The device consists of a transmitter and a sensor.
 The device is available as a compact version:
 The transmitter and sensor form a mechanical unit.

Transmitter

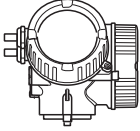
| | |
|---|--|
| <p>Promag 200</p>  <p style="text-align: right; font-size: small;">A0013471</p> | <p>Materials: Aluminum, AlSi10Mg, coated</p> <p>Configuration:</p> <ul style="list-style-type: none"> ■ External operation via four-line, illuminated local display with touch control and guided menus ("Make-it-run" wizards) for applications ■ Via operating tools (e.g. FieldCare) |
|---|--|

Sensor

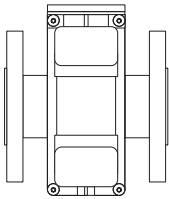
| | |
|---|--|
| <p>Promag P</p>  <p style="text-align: right; font-size: small;">A0017703</p> | <p>Nominal diameter range: DN 15 to 200 (½ to 8")</p> <p>Materials:</p> <ul style="list-style-type: none"> ■ Sensor housing: aluminum, AlSi10Mg, coated ■ Measuring tubes: stainless steel, 1.4301/1.4306 ■ Liner: PFA, PTFE ■ Electrodes: stainless steel, 1.4435 (F316L); Alloy C22, 2.4602 (UNS N06022); platinum; tantalum; titanium ■ Process connections: stainless steel, 1.0425/316L/1.4571/316L; carbon steel, A105/F316L/FE410WB/HII/S235JRG2; Alloy C22, 2.4602 (UNS N06022) ■ Seals: as per DIN EN 1514-1 ■ Ground disks: stainless steel, 1.4435 (316L); Alloy C22, 2.4602 (UNS N06022); tantalum; titanium |
|---|--|

Safety

IT security

We only provide a warranty if the device is installed and used as described in the Operating Instructions. The device is equipped with security mechanisms to protect it against any inadvertent changes to the device settings.

IT security measures in line with operators' security standards and designed to provide additional protection for the device and device data transfer must be implemented by the operators themselves.

Input

Measured variable

Direct measured variables

Volume flow (proportional to induced voltage)

Calculated measured variables

Mass flow

Measuring range



Typically $v = 0.01$ to 10 m/s (0.03 to 33 ft/s) with the specified accuracy

Flow characteristic values in SI units

| Nominal diameter | | Recommended flow Min./max. full scale value (v ~ 0.3/10 m/s) [dm ³ /min] | Factory settings | | |
|------------------|------|--|--|--|--|
| [mm] | [in] | | Full scale value current output (v ~ 2.5 m/s) [dm ³ /min] | Pulse value (~ 2 pulse/s) [dm ³] | Low flow cut off (v ~ 0.04 m/s) [dm ³ /min] |
| 15 | ½ | 4 to 100 | 25 | 0,2 | 0,5 |
| 25 | 1 | 9 to 300 | 75 | 0,5 | 1 |
| 32 | – | 15 to 500 | 125 | 1 | 2 |
| 40 | 1 ½ | 25 to 700 | 200 | 1,5 | 3 |
| 50 | 2 | 35 to 1 100 | 300 | 2,5 | 5 |
| 65 | – | 60 to 2 000 | 500 | 5 | 8 |
| 80 | 3 | 90 to 3 000 | 750 | 5 | 12 |
| 100 | 4 | 145 to 4 700 | 1200 | 10 | 20 |
| 125 | – | 220 to 7 500 | 1850 | 15 | 30 |
| 150 | 6 | 20 to 600 m ³ /h | 150 m ³ /h | 0.03 m ³ | 2.5 m ³ /h |
| 200 | 8 | 35 to 1 100 m ³ /h | 300 m ³ /h | 0.05 m ³ | 5 m ³ /h |

Flow characteristic values in US units

| Nominal diameter | | Recommended flow Min./max. full scale value (v ~ 0.3/10 m/s) [gal/min] | Factory settings | | |
|------------------|------|---|---|---------------------------------------|---|
| [in] | [mm] | | Full scale value current output (v ~ 2.5 m/s) [gal/min] | Pulse value (~ 2 pulse/s) [gal] | Low flow cut off (v ~ 0.04 m/s) [gal/min] |
| ½ | 15 | 1.0 to 27 | 6 | 0,1 | 0,15 |
| 1 | 25 | 2.5 to 80 | 18 | 0,2 | 0,25 |
| 1 ½ | 40 | 7 to 190 | 50 | 0,5 | 0,75 |
| 2 | 50 | 10 to 300 | 75 | 0,5 | 1,25 |
| 3 | 80 | 24 to 800 | 200 | 2 | 2,5 |
| 4 | 100 | 40 to 1 250 | 300 | 2 | 4 |
| 6 | 150 | 90 to 2 650 | 600 | 5 | 12 |
| 8 | 200 | 155 to 4 850 | 1200 | 10 | 15 |

 To calculate the measuring range, use the *Applicator* sizing tool →  49

Recommended measuring range

"Flow limit" section →  34

Operable flow range

Over 1000 : 1

Output

Output signal

Current output

| | |
|-------------------------------|--|
| Current output | 4-20 mA HART (passive) |
| Resolution | < 1 μ A |
| Damping | Adjustable: 0.0 to 999.9 s |
| Assignable measured variables | <ul style="list-style-type: none"> ▪ Volume flow ▪ Mass flow |

Pulse/frequency/switch output

| | |
|-------------------------------|--|
| Function | Can be set to pulse, frequency or switch output |
| Version | Passive, open collector |
| Maximum input values | <ul style="list-style-type: none"> ▪ DC 35 V ▪ 50 mA  For information on the Ex connection values → 10 |
| Voltage drop | <ul style="list-style-type: none"> ▪ For \leq 2 mA: 2 V ▪ For 10 mA: 8 V |
| Residual current | \leq 0.05 mA |
| Pulse output | |
| Pulse width | Adjustable: 5 to 2 000 ms |
| Maximum pulse rate | 100 Impulse/s |
| Pulse value | Adjustable |
| Assignable measured variables | <ul style="list-style-type: none"> ▪ Volume flow ▪ Mass flow |
| Frequency output | |
| Output frequency | Adjustable: 0 to 1 000 Hz |
| Damping | Adjustable: 0 to 999 s |
| Pulse/pause ratio | 1:1 |
| Assignable measured variables | <ul style="list-style-type: none"> ▪ Volume flow ▪ Mass flow |
| Switch output | |
| Switching behavior | Binary, conductive or non-conductive |
| Switching delay | Adjustable: 0 to 100 s |
| Number of switching cycles | Unlimited |
| Assignable functions | <ul style="list-style-type: none"> ▪ Off ▪ On ▪ Diagnostic behavior ▪ Limit value <ul style="list-style-type: none"> - Volume flow - Mass flow ▪ Flow direction monitoring ▪ Status <ul style="list-style-type: none"> - Empty pipe detection - Low flow cut off |

FOUNDATION Fieldbus

| | |
|------------------------|------------------------------|
| Signal encoding | Manchester Bus Powered (MBP) |
| Data transfer | 31.25 KBit/s, Voltage mode |

PROFIBUS PA

| | |
|------------------------|------------------------------|
| Signal encoding | Manchester Bus Powered (MBP) |
| Data transfer | 31.25 KBit/s, Voltage mode |

Signal on alarm

Depending on the interface, failure information is displayed as follows:

Current output*HART*

| | |
|---------------------------|--|
| Device diagnostics | Device condition can be read out via HART Command 48 |
|---------------------------|--|

Pulse/frequency/switch output*Pulse output*

| | |
|---------------------|--|
| Failure mode | Choose from: <ul style="list-style-type: none"> ■ Actual value ■ No pulses |
|---------------------|--|

Frequency output

| | |
|---------------------|--|
| Failure mode | Choose from: <ul style="list-style-type: none"> ■ Actual value ■ 0 Hz ■ Defined value: 0 to 1250 Hz |
|---------------------|--|

Switch output

| | |
|---------------------|---|
| Failure mode | Choose from: <ul style="list-style-type: none"> ■ Current status ■ Open ■ Closed |
|---------------------|---|

FOUNDATION Fieldbus

| | |
|---|---------------------------------------|
| Status and alarm messages | Diagnostics in accordance with FF-912 |
| Error current FDE (Fault Disconnection Electronic) | 0 mA |

PROFIBUS PA

| | |
|---|---|
| Status and alarm messages | Diagnostics in accordance with PROFIBUS PA Profile 3.02 |
| Error current FDE (Fault Disconnection Electronic) | 0 mA |

Local display



| | |
|---------------------------|---|
| Plain text display | With information on cause and remedial measures |
| Backlight | Additionally for device version with SD03 local display: red lighting indicates a device error. |

 Status signal as per NAMUR recommendation NE 107

Operating tool

- Via digital communication:
 - HART protocol
 - FOUNDATION Fieldbus
 - PROFIBUS PA
- Via service interface

| | |
|---------------------------|---|
| Plain text display | With information on cause and remedial measures |
|---------------------------|---|

 Additional information on remote operation →  42

Load

Load for current output: 0 to 500 Ω, depending on the external supply voltage of the power supply unit

Calculation of the maximum load

Depending on the supply voltage of the power supply unit (U_S), the maximum load (R_B) including line resistance must be observed to ensure adequate terminal voltage at the device. In doing so, observe the minimum terminal voltage

- For $U_S = 18$ to 18.9 V: $R_B \leq (U_S - 18 \text{ V}): 0.0036 \text{ A}$
- For $U_S = 18.9$ to 24.5 V: $R_B \leq (U_S - 13.5 \text{ V}): 0.022 \text{ A}$
- For $U_S = 24.5$ to 30 V: $R_B \leq 500 \text{ } \Omega$

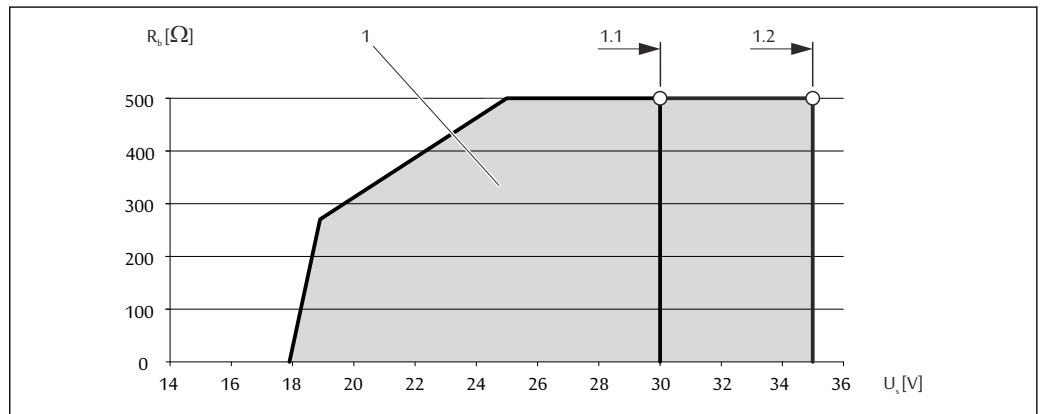

A0013563

- 1 Operating range
- 1.1 For order code for "Output", option A "4-20 mA HART"/option B "4-20 mA HART, pulse/frequency/switch output" with Ex i
- 1.2 For order code for "Output", option A "4-20 mA HART"/option B "4-20 mA HART, pulse/frequency/switch output" with non-Ex and Ex d

Sample calculation

Supply voltage of the power supply unit: $U_S = 19 \text{ V}$
 Maximum load: $R_B \leq (19 \text{ V} - 13.5 \text{ V}): 0.022 \text{ A} = 250 \text{ } \Omega$

Ex connection data

Safety-related values

Type of protection *Ex d*

| Order code for "Output" | Output type | Safety-related values |
|-------------------------|-------------------------------|--|
| Option A | 4-20mA HART | $U_{nom} = DC 35 V$ $U_{max} = 250 V$ |
| Option B | 4-20mA HART | $U_{nom} = DC 35 V$ $U_{max} = 250 V$ |
| | Pulse/frequency/switch output | $U_{nom} = DC 35 V$ $U_{max} = 250 V$ $P_{max} = 1 W^{1)}$ |
| Option E | FOUNDATION Fieldbus | $U_{nom} = DC 32 V$ $U_{max} = 250 V$ $P_{max} = 0.88 W$ |
| | Pulse/frequency/switch output | $U_{nom} = DC 35 V$ $U_{max} = 250 V$ $P_{max} = 1 W^{1)}$ |
| Option G | PROFIBUS PA | $U_{nom} = DC 32 V$ $U_{max} = 250 V$ $P_{max} = 0.88 W$ |
| | Pulse/frequency/switch output | $U_{nom} = DC 35 V$ $U_{max} = 250 V$ $P_{max} = 1 W^{1)}$ |

1) Internal circuit limited by $R_i = 760.5 \Omega$ *Ex nA type of protection*

| Order code for "Output" | Output type | Safety-related values |
|-------------------------|-------------------------------|--|
| Option A | 4-20mA HART | $U_{nom} = DC 35 V$ $U_{max} = 250 V$ |
| Option B | 4-20mA HART | $U_{nom} = DC 35 V$ $U_{max} = 250 V$ |
| | Pulse/frequency/switch output | $U_{nom} = DC 35 V$ $U_{max} = 250 V$ $P_{max} = 1 W^{1)}$ |
| Option E | FOUNDATION Fieldbus | $U_{nom} = DC 32 V$ $U_{max} = 250 V$ $P_{max} = 0.88 W$ |
| | Pulse/frequency/switch output | $U_{nom} = DC 35 V$ $U_{max} = 250 V$ $P_{max} = 1 W^{1)}$ |
| Option G | PROFIBUS PA | $U_{nom} = DC 32 V$ $U_{max} = 250 V$ $P_{max} = 0.88 W$ |
| | Pulse/frequency/switch output | $U_{nom} = DC 35 V$ $U_{max} = 250 V$ $P_{max} = 1 W^{1)}$ |

1) Internal circuit limited by $R_i = 760.5 \Omega$

Type of protection *XP*

| Order code for "Output" | Output type | Safety-related values |
|-------------------------|-------------------------------|---|
| Option A | 4-20mA HART | $U_{nom} = DC 35 V$ $U_{max} = 250 V$ |
| Option B | 4-20mA HART | $U_{nom} = DC 35 V$ $U_{max} = 250 V$ |
| | Pulse/frequency/switch output | $U_{nom} = DC 35 V$ $U_{max} = 250 V$ $P_{max} = 1 W$ ¹⁾ |
| Option E | FOUNDATION Fieldbus | $U_{nom} = DC 32 V$ $U_{max} = 250 V$ $P_{max} = 0.88 W$ |
| | Pulse/frequency/switch output | $U_{nom} = DC 35 V$ $U_{max} = 250 V$ $P_{max} = 1 W$ ¹⁾ |
| Option G | PROFIBUS PA | $U_{nom} = DC 32 V$ $U_{max} = 250 V$ $P_{max} = 0.88 W$ |
| | Pulse/frequency/switch output | $U_{nom} = DC 35 V$ $U_{max} = 250 V$ $P_{max} = 1 W$ ¹⁾ |

1) Internal circuit limited by $R_i = 760.5 \Omega$

Intrinsically safe values

Type of protection *Ex ia*

| Order code for "Output" | Output type | Intrinsically safe values | |
|-------------------------|-------------------------------|---|--|
| Option A | 4-20mA HART | $U_i = DC 30 V$ $I_i = 300 mA$ $P_i = 1 W$ $L_i = 0 \mu H$ $C_i = 5 nF$ | |
| Option B | 4-20mA HART | $U_i = DC 30 V$ $I_i = 300 mA$ $P_i = 1 W$ $L_i = 0 \mu H$ $C_i = 5 nF$ | |
| | Pulse/frequency/switch output | $U_i = DC 30 V$ $I_i = 300 mA$ $P_i = 1 W$ $L_i = 0 \mu H$ $C_i = 6 nF$ | |
| Option E | FOUNDATION Fieldbus | STANDARD $U_i = 30 V$ $I_i = 300 mA$ $P_i = 1.2 W$ $L_i = 10 \mu H$ $C_i = 5 nF$ | FISCO $U_i = 17.5 V$ $I_i = 550 mA$ $P_i = 5.5 W$ $L_i = 10 \mu H$ $C_i = 5 nF$ |
| | Pulse/frequency/switch output | $U_i = 30 V$ $I_i = 300 mA$ $P_i = 1 W$ $L_i = 0 \mu H$ $C_i = 6 nF$ | |

| Order code for "Output" | Output type | Intrinsically safe values | |
|-------------------------|-------------------------------|---|--|
| Option G | PROFIBUS PA | STANDARD U _i = 30 V I _i = 300 mA P _i = 1.2 W L _i = 10 µH C _i = 5 nF | FISCO U _i = 17.5 V I _i = 550 mA P _i = 5.5 W L _i = 10 µH C _i = 5 nF |
| | Pulse/frequency/switch output | U _i = 30 V I _i = 300 mA P _i = 1 W L _i = 0 µH C _i = 6 nF | |

Type of protection Ex ic

| Order code for "Output" | Output type | Intrinsically safe values | |
|-------------------------|-------------------------------|--|---|
| Option A | 4-20mA HART | U _i = DC 35 V I _i = n.a. P _i = 1 W L _i = 0 µH C _i = 5 nF | |
| Option B | 4-20mA HART | U _i = DC 35 V I _i = n.a. P _i = 1 W L _i = 0 µH C _i = 5 nF | |
| | Pulse/frequency/switch output | U _i = DC 35 V I _i = n.a. P _i = 1 W L _i = 0 µH C _i = 6 nF | |
| Option E | FOUNDATION Fieldbus | STANDARD U _i = 32 V I _i = 300 mA P _i = n.a. L _i = 10 µH C _i = 5 nF | FISCO U _i = 17.5 V I _i = n.a. P _i = n.a. L _i = 10 µH C _i = 5 nF |
| | Pulse/frequency/switch output | U _i = 35 V I _i = 300 mA P _i = 1 W L _i = 0 µH C _i = 6 nF | |
| Option G | PROFIBUS PA | STANDARD U _i = 32 V I _i = 300 mA P _i = n.a. L _i = 10 µH C _i = 5 nF | FISCO U _i = 17.5 V I _i = n.a. P _i = n.a. L _i = 10 µH C _i = 5 nF |
| | Pulse/frequency/switch output | U _i = 35 V I _i = 300 mA P _i = 1 W L _i = 0 µH C _i = 6 nF | |

Type of protection IS

| Order code for "Output" | Output type | Intrinsically safe values | |
|-------------------------|-------------------------------|--|---|
| Option A | 4-20mA HART | $U_i = DC\ 30\ V$ $I_i = 300\ mA$ $P_i = 1\ W$ $L_i = 0\ \mu H$ $C_i = 5\ nF$ | |
| Option B | 4-20mA HART | $U_i = DC\ 30\ V$ $I_i = 300\ mA$ $P_i = 1\ W$ $L_i = 0\ \mu H$ $C_i = 5\ nF$ | |
| | Pulse/frequency/switch output | $U_i = DC\ 30\ V$ $I_i = 300\ mA$ $P_i = 1\ W$ $L_i = 0\ \mu H$ $C_i = 6\ nF$ | |
| Option E | FOUNDATION Fieldbus | STANDARD $U_i = 30\ V$ $I_i = 300\ mA$ $P_i = 1.2\ W$ $L_i = 10\ \mu H$ $C_i = 5\ nF$ | FISCO $U_i = 17.5\ V$ $I_i = 550\ mA$ $P_i = 5.5\ W$ $L_i = 10\ \mu H$ $C_i = 5\ nF$ |
| | Pulse/frequency/switch output | $U_i = 30\ V$ $I_i = 300\ mA$ $P_i = 1\ W$ $L_i = 0\ \mu H$ $C_i = 6\ nF$ | |
| Option G | PROFIBUS PA | STANDARD $U_i = 30\ V$ $I_i = 300\ mA$ $P_i = 1.2\ W$ $L_i = 10\ \mu H$ $C_i = 5\ nF$ | FISCO $U_i = 17.5\ V$ $I_i = 550\ mA$ $P_i = 5.5\ W$ $L_i = 10\ \mu H$ $C_i = 5\ nF$ |
| | Pulse/frequency/switch output | $U_i = 30\ V$ $I_i = 300\ mA$ $P_i = 1\ W$ $L_i = 0\ \mu H$ $C_i = 6\ nF$ | |

Low flow cut off The switch points for low flow cut off are user-selectable.

Galvanic isolation All outputs are galvanically isolated from one another.

Protocol-specific data HART

| | |
|------------------------------------|--|
| Manufacturer ID | 0x11 |
| Device type ID | 0x48 |
| HART protocol revision | 7 |
| Device description files (DTM, DD) | Information and files under: www.endress.com |
| HART load | <ul style="list-style-type: none"> ▪ Min. 250 Ω ▪ Max. 500 Ω |

| | |
|--------------------------|--|
| Dynamic variables | <p>Read out the dynamic variables: HART command 3 The measured variables can be freely assigned to the dynamic variables.</p> <p>Measured variables for PV (primary dynamic variable)</p> <ul style="list-style-type: none"> ▪ Off ▪ Volume flow ▪ Mass flow <p>Measured variables for SV, TV, QV (secondary, tertiary and quaternary dynamic variable)</p> <ul style="list-style-type: none"> ▪ Volume flow ▪ Mass flow ▪ Totalizer 1 ▪ Totalizer 2 ▪ Totalizer 3 |
| Device variables | <p>Read out the device variables: HART command 9 The device variables are permanently assigned.</p> |

FOUNDATION Fieldbus

| | |
|---|--|
| Manufacturer ID | 0x452B48 |
| Ident number | 0x1048 |
| Device revision | 1 |
| DD revision | Information and files under: |
| CFF revision | <ul style="list-style-type: none"> ▪ www.endress.com ▪ www.fieldbus.org |
| Device Tester Version (ITK version) | 6.1.1 |
| ITK Test Campaign Number | IT094200 |
| Link Master capability (LAS) | Yes |
| Choice of "Link Master" and "Basic Device" | Yes Factory setting: Basic Device |
| Node address | Factory setting: 247 (0xF7) |
| Supported functions | <p>The following methods are supported:</p> <ul style="list-style-type: none"> ▪ Restart ▪ ENP Restart ▪ Diagnostic |
| Virtual Communication Relationships (VCRs) | |
| Number of VCRs | 44 |
| Number of link objects in VFD | 50 |
| Permanent entries | 1 |
| Client VCRs | 0 |
| Server VCRs | 10 |
| Source VCRs | 43 |
| Sink VCRs | 0 |
| Subscriber VCRs | 43 |
| Publisher VCRs | 43 |
| Device Link Capabilities | |
| Slot time | 4 |
| Min. delay between PDU | 8 |
| Max. response delay | Min. 5 |

Transducer Blocks

| Block | Contents | Output values |
|---|--|---|
| Setup Transducer Block (TRDSUP) | All parameters for standard commissioning. | No output values |
| Advanced Setup Transducer Block (TRDASUP) | All parameters for more accurate measurement configuration. | No output values |
| Display Transducer Block (TRDDISP) | Parameters for configuring the local display. | No output values |
| HistoROM Transducer Block (TRDHROM) | Parameters for using the HistoROM function. | No output values |
| Diagnostic Transducer Block (TRDDIAG) | Diagnostics information. | Process variables (AI Channel) <ul style="list-style-type: none"> ▪ Temperature (7) ▪ Volume flow (9) ▪ Mass flow (11) |
| Expert Configuration Transducer Block (TRDEXP) | Parameters that require the user to have in-depth knowledge of the operation of the device in order to configure the parameters appropriately. | No output values |
| Expert Information Transducer Block (TRDEXPIN) | Parameters that provide information about the state of the device. | No output values |
| Service Sensor Transducer Block (TRDSRVS) | Parameters that can only be accessed by Endress+Hauser Service. | No output values |
| Service Information Transducer Block (TRDSRVIF) | Parameters that provide Endress+Hauser Service with information about the state of the device. | No output values |
| Total Inventory Counter Transducer Block (TRDTIC) | Parameters for configuring all the totalizers and the inventory counter. | Process variables (AI Channel) <ul style="list-style-type: none"> ▪ Totalizer 1 (16) ▪ Totalizer 2 (17) ▪ Totalizer 3 (18) |
| Heartbeat Technology Transducer Block (TRDHBT) | Parameters for the configuration and comprehensive information about the results of the verification. | No output values |
| Heartbeat Results 1 Transducer Block (TRDHBTR1) | Information about the results of the verification. | No output values |
| Heartbeat Results 2 Transducer Block (TRDHBTR2) | Information about the results of the verification. | No output values |
| Heartbeat Results 3 Transducer Block (TRDHBTR3) | Information about the results of the verification. | No output values |
| Heartbeat Results 4 Transducer Block (TRDHBTR4) | Information about the results of the verification. | No output values |

Function blocks

| Block | Number of blocks | Contents | Process variables (Channel) |
|-------------------------------------|------------------|--|---|
| Resource Block (RB) | 1 | This Block (extended functionality) contains all the data that uniquely identify the device; it is the equivalent of an electronic nameplate for the device. | – |
| Analog Input Block (AI) | 4 | This Block (extended functionality) receives the measurement data provided by the Sensor Block (can be selected via a channel number) and makes the data available for other blocks at the output. Execution time: 25 ms | Process variables (AI Channel) <ul style="list-style-type: none"> ▪ Temperature (7) ▪ Volume flow (9) ▪ Mass flow (11) |
| Discrete Input Block (DI) | 2 | This Block (standard functionality) receives a discrete value (e.g. indicator that measuring range has been exceeded) and makes the value available for other blocks at the output. Execution time: 19 ms | <ul style="list-style-type: none"> ▪ Switch output state (101) ▪ Empty pipe detection (102) ▪ Low flow cut off (103) ▪ Status verification (105) |
| PID Block (PID) | 1 | This Block (standard functionality) acts as a proportional-integral-differential controller and can be used universally for control in the field. It enables cascading and feedforward control. Execution time: 25 ms | – |
| Multiple Digital Output Block (MDO) | 1 | This Block (standard functionality) receives several discrete values and makes them available for other blocks at the output. Execution time: 19 ms | Channel_DO (122) <ul style="list-style-type: none"> ▪ Value 1: Reset totalizer 1 ▪ Value 2: Reset totalizer 2 ▪ Value 3: Reset totalizer 3 ▪ Value 4: Flow override ▪ Value 5: Start heartbeat verification ▪ Value 6: Status switch output ▪ Value 7: Not assigned ▪ Value 8: Not assigned |
| Integrator Block (IT) | 1 | This Block (standard functionality) integrates a measured variable over time or totalizes the pulses from a Pulse Input Block. The Block can be used as a totalizer that totalizes until a reset, or as a batch totalizer whereby the integrated value is compared against a target value generated before or during the control routine and generates a binary signal when the target value is reached. Execution time: 21 ms | – |

PROFIBUS PA

| | |
|---|---|
| Manufacturer ID | 0x11 |
| Ident number | 0x1563 |
| Profile version | 3.02 |
| Device description files (GSD, DTM, DD) | Information and files under: <ul style="list-style-type: none"> ▪ www.endress.com ▪ www.profibus.org |

| | |
|--|--|
| <p>Output values (from measuring device to automation system)</p> | <p>Analog input 1 to 2</p> <ul style="list-style-type: none"> ▪ Mass flow ▪ Volume flow <p>Digital input 1 to 2</p> <ul style="list-style-type: none"> ▪ Empty pipe detection ▪ Low flow cut off ▪ Status switch output ▪ Status verification <p>Totalizer 1 to 3</p> <ul style="list-style-type: none"> ▪ Mass flow ▪ Volume flow ▪ Corrected volume flow |
| <p>Input values (from automation system to measuring device)</p> | <p>Digital output 1 to 3 (fixed assignment)</p> <ul style="list-style-type: none"> ▪ Digital output 1: switch positive zero return on/off ▪ Digital output 2: switch switch output on/off ▪ Digital output 3: start verification <p>Totalizer 1 to 3</p> <ul style="list-style-type: none"> ▪ Totalize ▪ Reset and hold ▪ Preset and hold ▪ Operating mode configuration: <ul style="list-style-type: none"> - Net flow total - Forward flow total - Reverse flow total |
| <p>Supported functions</p> | <ul style="list-style-type: none"> ▪ Identification & Maintenance Simplest device identification on the part of the control system and nameplate ▪ PROFIBUS upload/download Reading and writing parameters is up to ten times faster with PROFIBUS upload/download ▪ Condensed status Simplest and self-explanatory diagnostic information by categorizing diagnostic messages that occur |
| <p>Configuration of the device address</p> | <ul style="list-style-type: none"> ▪ DIP switches on the I/O electronics module ▪ Local display ▪ via operating tools (e.g. FieldCare) |

Power supply

Terminal assignment

Transmitter

Connection versions

| | |
|---|--|
| | |
| <p>Maximum number of terminals, without integrated overvoltage protection</p> | <p>Maximum number of terminals, with integrated overvoltage protection</p> |
| <p>1 Output 1 (passive): supply voltage and signal transmission 2 Output 2 (passive): supply voltage and signal transmission 3 Ground terminal for cable shield</p> | |

| Order code for "Output" | Terminal numbers | | | |
|----------------------------------|------------------------|-------|---|-------|
| | Output 1 | | Output 2 | |
| | 1 (+) | 2 (-) | 3 (+) | 4 (-) |
| Option A | 4-20 mA HART (passive) | | - | |
| Option B ¹⁾ | 4-20 mA HART (passive) | | Pulse/frequency/switch output (passive) | |
| Option E ^{1) 2)} | FOUNDATION Fieldbus | | Pulse/frequency/switch output (passive) | |
| Option G ^{1) 3)} | PROFIBUS PA | | Pulse/frequency/switch output (passive) | |

- 1) Output 1 must always be used; output 2 is optional.
2) FOUNDATION Fieldbus with integrated reverse polarity protection.
3) PROFIBUS PA with integrated reverse polarity protection.

Pin assignment, device plug**PROFIBUS PA**

Device plug for signal transmission (device side)

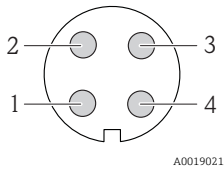
|  | Pin | Assignment | Coding | Plug/socket | |
|--|-----|------------|---------------|-------------|------|
| | 1 | + | PROFIBUS PA + | A | Plug |
| | 2 | | Grounding | | |
| | 3 | - | PROFIBUS PA - | | |
| | 4 | | Not assigned | | |

FOUNDATION Fieldbus

Device plug for signal transmission (device side)

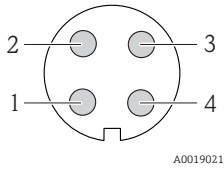
|  | Pin | Assignment | Coding | Plug/socket | |
|---|-----|------------|--------------|-------------|------|
| | 1 | + | Signal + | A | Plug |
| | 2 | - | Signal - | | |
| | 3 | | Not assigned | | |
| | 4 | | Grounding | | |



Supply voltage**Transmitter**

An external power supply is required for each output.



| Order code for "Output" | Minimum terminal voltage | Maximum terminal voltage |
|--|---|--------------------------|
| Option A ^{1) 2)} : 4-20 mA HART | <ul style="list-style-type: none"> ■ For 4 mA: ≥ DC 18 V ■ For 20 mA: ≥ DC 14 V | DC 35 V |
| Option B ^{1) 2)} : 4-20 mA HART, pulse/frequency/switch output | <ul style="list-style-type: none"> ■ For 4 mA: ≥ DC 18 V ■ For 20 mA: ≥ DC 14 V | DC 35 V |

| Order code for "Output" | Minimum terminal voltage | Maximum terminal voltage |
|--|--------------------------|--------------------------|
| Option E ³⁾ : FOUNDATION Fieldbus, pulse/frequency/switch output | ≥ DC 9 V | DC 32 V |
| Option G ³⁾ : PROFIBUS PA, pulse/frequency/switch output | ≥ DC 9 V | DC 32 V |

- 1) External supply voltage of the power supply unit with load.
- 2) For device versions with SD03 local display: The terminal voltage must be increased by DC 2 V if backlighting is used.
- 3) For device version with SD03 local display: The terminal voltage must be increased by DC 0.5 V if backlighting is used.

 For information about the load see →  9

 Various power supply units can be ordered from Endress+Hauser: see "Accessories" section →  50

 For information on the Ex connection values →  10

Power consumption

Transmitter

| Order code for "Output" | Maximum power consumption |
|--|--|
| Option A : 4-20 mA HART | 770 mW |
| Option B : 4-20 mA HART, pulse/frequency/switch output | <ul style="list-style-type: none"> ▪ Operation with output 1: 770 mW ▪ Operation with output 1 and 2: 2 770 mW |
| Option E : FOUNDATION Fieldbus, pulse/frequency/switch output | <ul style="list-style-type: none"> ▪ Operation with output 1: 576 mW ▪ Operation with output 1 and 2: 2 576 mW |
| Option G : PROFIBUS PA, pulse/frequency/switch output | <ul style="list-style-type: none"> ▪ Operation with output 1: 512 mW ▪ Operation with output 1 and 2: 2 512 mW |

 For information on the Ex connection values →  10

Current consumption

Current output

For every 4-20 mA or 4-20 mA HART current output: 3.6 to 22.5 mA

 If the option **Defined value** is selected in the **Failure mode** parameter : 3.59 to 22.5 mA

PROFIBUS PA

16 mA

FOUNDATION Fieldbus

16 mA

Power supply failure

- Totalizers stop at the last value measured.
- Configuration is retained in the device memory (HistoROM).
- Error messages (incl. total operated hours) are stored.

Electrical connection

Connecting the transmitter

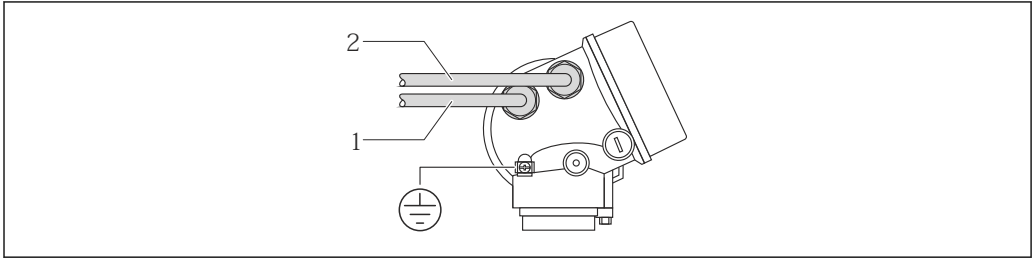

A0015510

- 1 Cable entry for output 1
- 2 Cable entry for output 2

Connection examples

Current output 4-20 mA HART

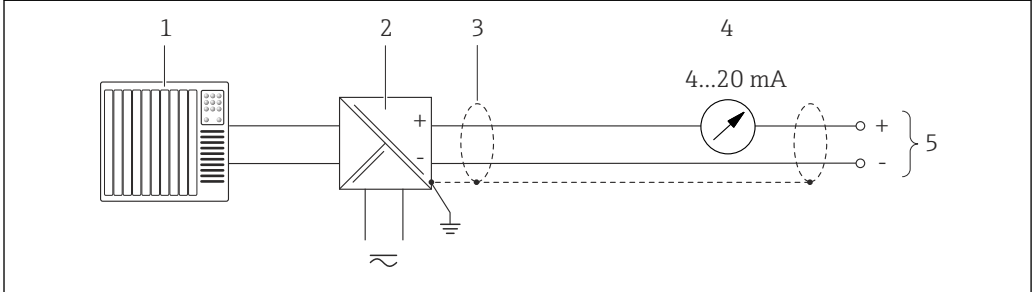

A0015511

- 1 Connection example for 4-20 mA HART current output (passive)
- 1 Automation system with current input (e.g. PLC)
- 2 Active barrier for power supply with integrated resistor for HART communication ($\geq 250 \Omega$) (e.g. RN221N)
 Connection for HART operating devices → 42
 Observe the maximum load → 9
- 3 Cable shield, observe cable specifications
- 4 Analog display unit: observe maximum load → 9
- 5 Transmitter

Pulse/frequency output

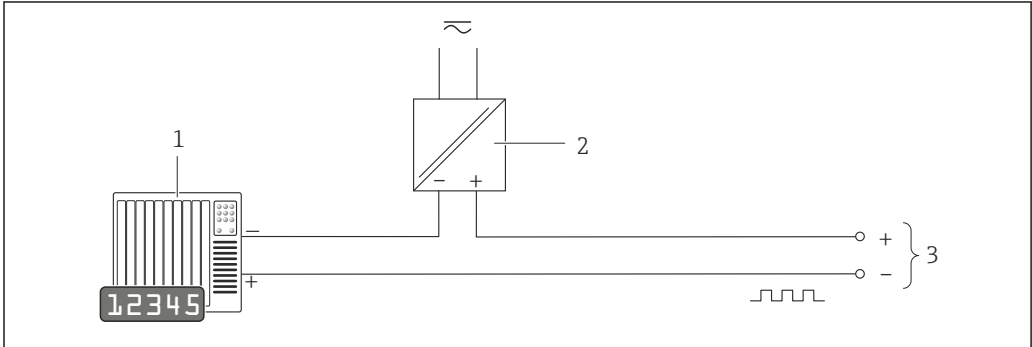

A0016801

- 2 Connection example for pulse/frequency output (passive)
- 1 Automation system with pulse/frequency input (e.g. PLC)
- 2 Power supply
- 3 Transmitter: observe input values → 7

Switch output

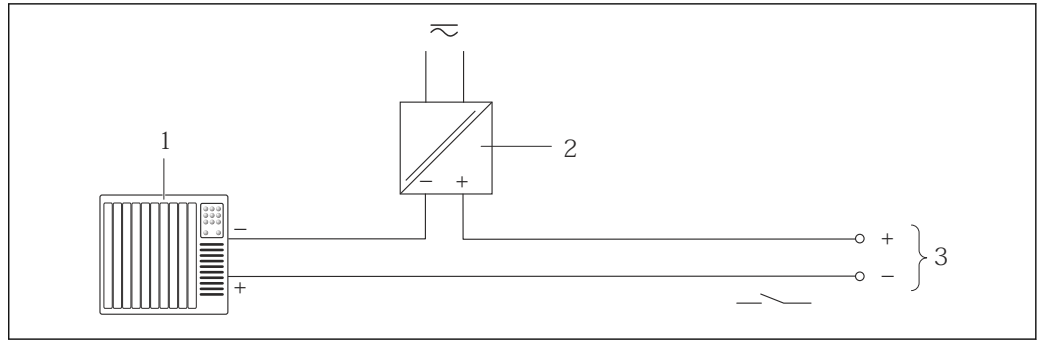

A0016802

3 Connection example for switch output (passive)

- 1 Automation system with switch input (e.g. PLC)
- 2 Power supply
- 3 Transmitter: observe input values

PROFIBUS-PA

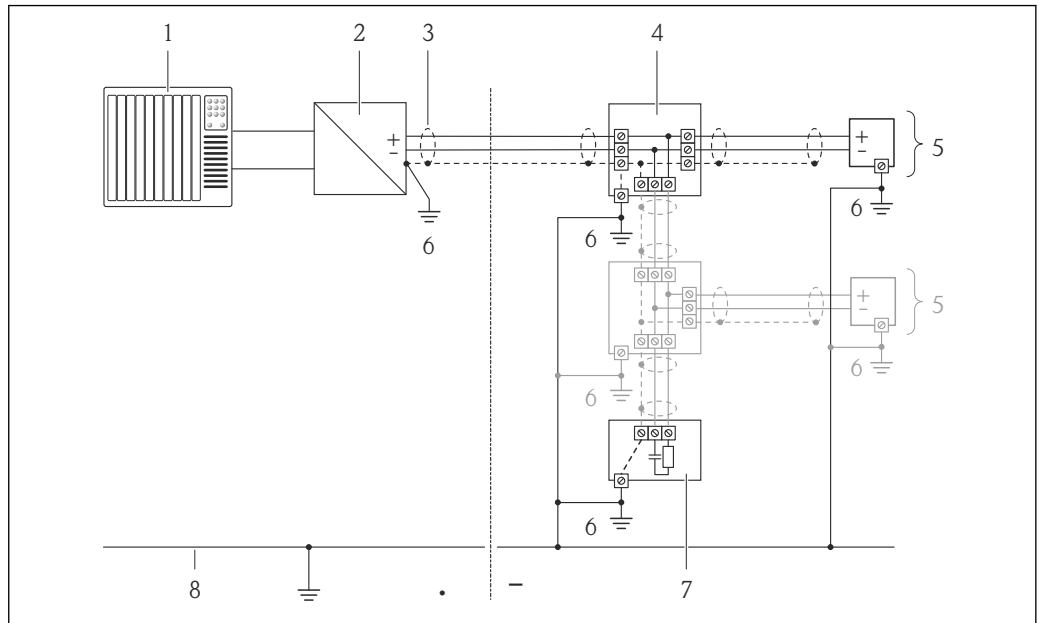

A0019004

4 Connection example for PROFIBUS-PA

- 1 Control system (e.g. PLC)
- 2 Segment coupler PROFIBUS DP/PA
- 3 Cable shield
- 4 T-box
- 5 Measuring device
- 6 Local grounding
- 7 Bus terminator
- 8 Potential matching line

FOUNDATION Fieldbus

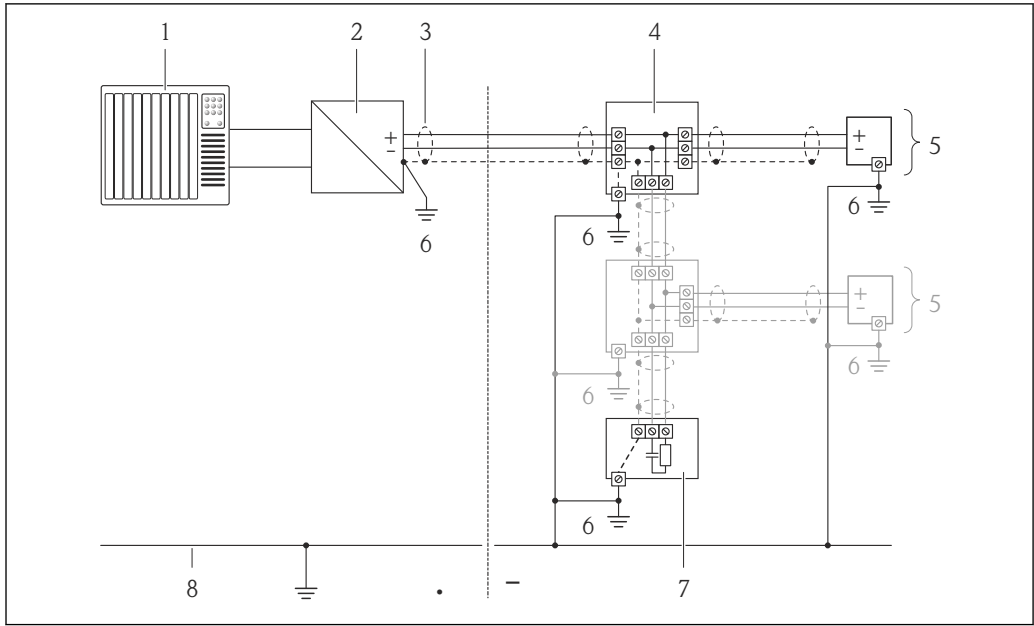

A0019004

5 Connection example for FOUNDATION Fieldbus

- 1 Control system (e.g. PLC)
- 2 Power Conditioner (FOUNDATION Fieldbus)
- 3 Cable shield
- 4 T-box
- 5 Measuring device
- 6 Local grounding
- 7 Bus terminator
- 8 Potential matching line

HART input

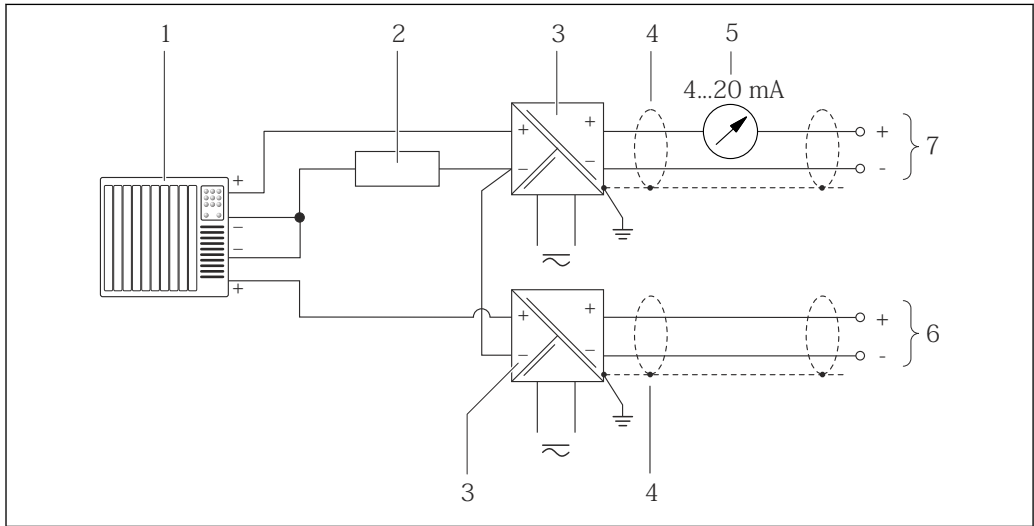

A0016029

6 Connection example for HART input with a common negative

- 1 Automation system with HART output (e.g. PLC)
- 2 Resistor for HART communication ($\geq 250 \Omega$): observe maximum load \rightarrow 9
- 3 Active barrier for power supply (e.g. RN221N)
- 4 Cable shield, observe cable specifications
- 5 Analog display unit: observe maximum load \rightarrow 9
- 6 Pressure transmitter (e.g. Cerabar M, Cerabar S): see requirements
- 7 Transmitter

Potential equalization

Requirements

Please consider the following to ensure correct measurement:

- Same electrical potential for the fluid and sensor
- Company-internal grounding concepts
- Pipe material and grounding



For devices intended for use in hazardous locations, please observe the guidelines in the Ex documentation (XA).

Connection example, standard scenario

Metal, grounded pipe

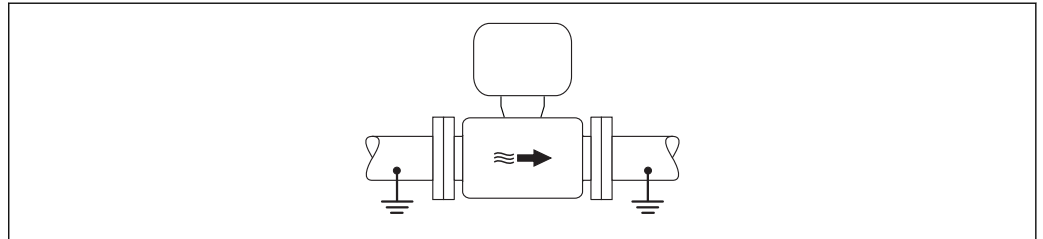

A0016315

7 Potential equalization via measuring tube

Connection example in special situations

Unlined and ungrounded metal pipe

This connection method also applies in situations where:

- The customary potential equalization is not used
- Equalizing currents are present

| | |
|---------------------|---|
| Ground cable | Copper wire, at least 6 mm ² (0.0093 in ²) |
|---------------------|---|

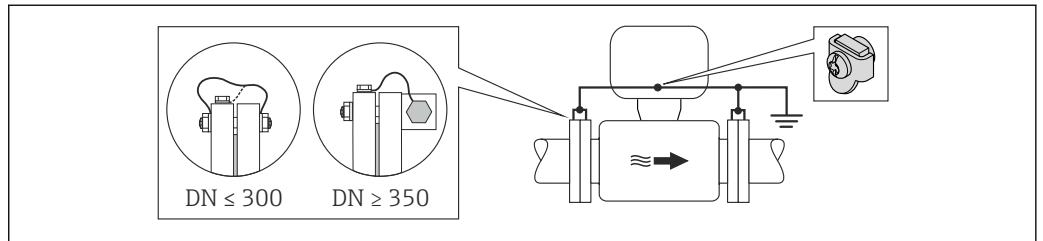

A0016317

8 Potential equalization via ground terminal and pipe flanges

Note the following when installing:

- Connect both sensor flanges to the pipe flange via a ground cable and ground them.
- Connect the connection housing of the transmitter or sensor to ground potential by means of the ground terminal provided for the purpose. To mount the ground cable:
 - If DN ≤ 300 (12"): Mount the ground cable directly on the conductive flange coating of the sensor with the flange screws.
 - If DN ≥ 350 (14"): Mount the ground cable directly on the metal transport bracket.



The necessary ground cable can be ordered from Endress+Hauser .

Plastic pipe or pipe with insulating liner

This connection method also applies in situations where:

- The customary potential equalization is not used
- Equalizing currents are present

| | |
|---------------------|---|
| Ground cable | Copper wire, at least 6 mm ² (0.0093 in ²) |
|---------------------|---|

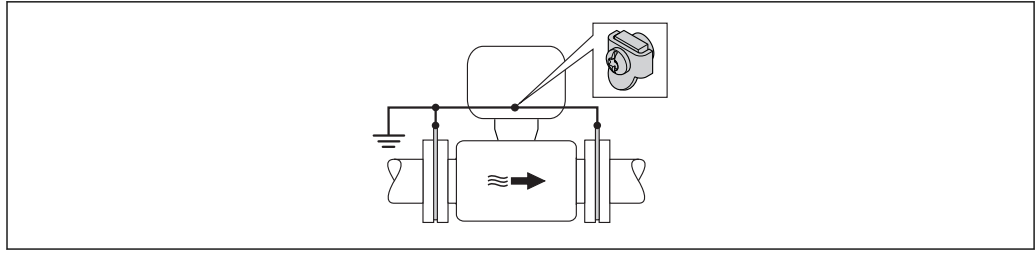

A0016318

9 Potential equalization via ground terminal and ground disks

Note the following when installing:

The ground disks must be connected to the ground terminal via the ground cable and be connected to ground potential.

i The ground cable and ground disks can be ordered from Endress+Hauser → 48.

Pipe with a cathodic protection unit

This connection method is only used if the following two conditions are met:

- Metal pipe without liner or pipe with electrically conductive liner
- Cathodic protection is integrated in the personal protection equipment

| | |
|---------------------|---|
| Ground cable | Copper wire, at least 6 mm ² (0.0093 in ²) |
|---------------------|---|

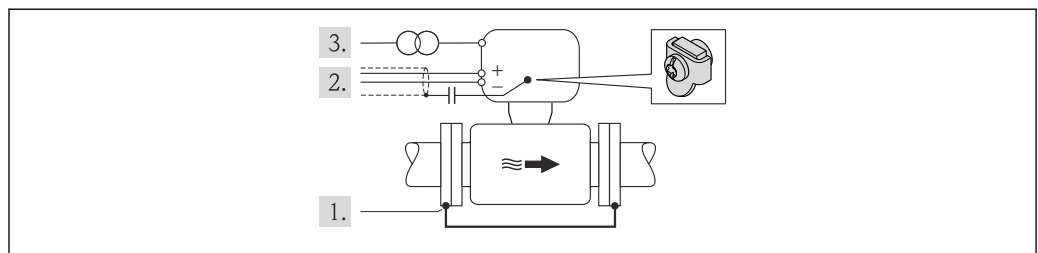

A0016319

Note the following when installing:

The sensor is installed in the pipe in a way that provides electrical insulation.

i The necessary ground cable can be ordered from Endress+Hauser .

Terminals

- For device version without integrated overvoltage protection: plug-in spring terminals for wire cross-sections 0.5 to 2.5 mm² (20 to 14 AWG)
- For device version with integrated overvoltage protection: screw terminals for wire cross-sections 0.2 to 2.5 mm² (24 to 14 AWG)

Cable entries

- Cable gland (not for Ex d): M20 × 1.5 with cable ϕ 6 to 12 mm (0.24 to 0.47 in)
- Thread for cable entry:
 - For non-Ex and Ex: NPT 1/2"
 - For non-Ex and Ex (not for CSA Ex d/XP): G 1/2"
 - For Ex d: M20 × 1.5

Cable specification

Permitted temperature range

- -40 °C (-40 °F) to +80 °C (+176 °F)
- Minimum requirement: cable temperature range \geq ambient temperature +20 K

Signal cable

Current output

For 4-20 mA HART: Shielded cable recommended. Observe grounding concept of the plant.

Pulse/frequency/switch output

Standard installation cable is sufficient.

FOUNDATION Fieldbus

Twisted, shielded two-wire cable.

 For further information on planning and installing FOUNDATION Fieldbus networks see:

- Operating Instructions for "FOUNDATION Fieldbus Overview" (BA00013S)
- FOUNDATION Fieldbus Guideline
- IEC 61158-2 (MBP)

PROFIBUS PA

Twisted, shielded two-wire cable. Cable type A is recommended.

 For further information on planning and installing PROFIBUS PA networks see:

- Operating Instructions "PROFIBUS DP/PA: Guidelines for planning and commissioning" (BA00034S)
- PNO Directive 2.092 "PROFIBUS PA User and Installation Guideline"
- IEC 61158-2 (MBP)

Overvoltage protection

The device can be ordered with integrated overvoltage protection for diverse approvals:
Order code for "Accessory mounted", option NA "Overvoltage protection"

| | |
|--|--|
| Input voltage range | Values correspond to supply voltage specifications ¹⁾ |
| Resistance per channel | 2 · 0.5 Ω max |
| DC sparkover voltage | 400 to 700 V |
| Trip surge voltage | < 800 V |
| Capacitance at 1 MHz | < 1.5 pF |
| Nominal discharge current (8/20 µs) | 10 kA |
| Temperature range | -40 to +85 °C (-40 to +185 °F) |

1) The voltage is reduced by the amount of the internal resistance $I_{min} \cdot R_i$

 Depending on the temperature class, restrictions apply to the ambient temperature for device versions with overvoltage protection

Performance characteristics



Reference operating conditions

In accordance with DIN EN 29104

- Water, typically 15 to 45 °C (59 to 113 °F); 2 to 6 bar (29 to 87 psi)
- Data as indicated in the calibration protocol ±5 °C (±41 °F) and ±2 bar (±29 psi)
- Accuracy based on accredited calibration rigs traced to ISO 17025
- Medium temperature: +28 ± 2 °C (+82 ± 4 °F)
- Ambient temperature: +22 ± 2 °C (+72 ± 4 °F)
- Warm-up period: 30 min

Installation

- Inlet run > 10 × DN
- Outlet run > 5 × DN
- Sensor and transmitter grounded.
- The sensor is centered in the pipe.

 To calculate the measuring range, use the *Applicator* sizing tool →  49

Maximum measured error

Error limits under reference operating conditions

o.r. = of reading

Volume flow

±0.5 % o.r. ± 2 mm/s (0.08 in/s)

i Fluctuations in the supply voltage do not have any effect within the specified range.

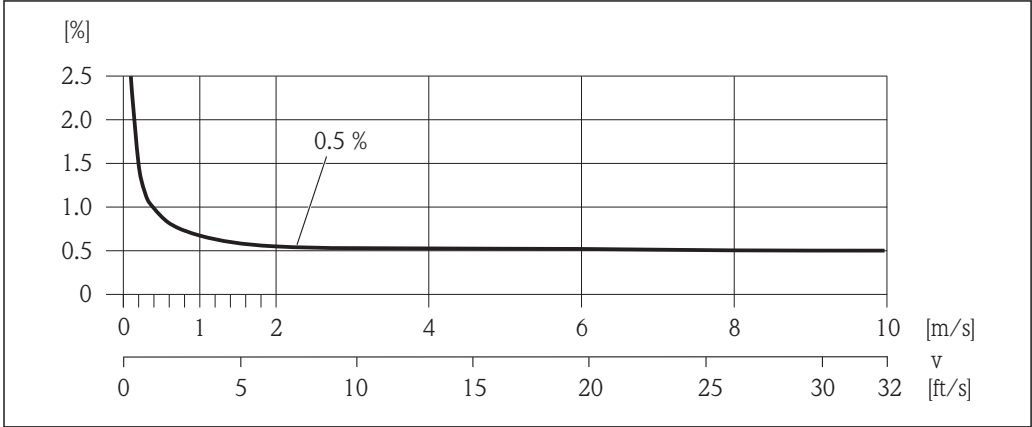

10 Maximum measured error in % o.r.

Accuracy of outputs

The outputs have the following base accuracy specifications.

Current output

| | |
|-----------------|--------|
| Accuracy | ±10 µA |
|-----------------|--------|

Pulse/frequency output

o.r. = of reading

| | |
|-----------------|--------------------|
| Accuracy | Max. ±100 ppm o.r. |
|-----------------|--------------------|

Repeatability

o.r. = of reading

Volume flow

Max. ±0.2 % o.r. ± 2 mm/s (0.08 in/s)

Influence of ambient temperature

Current output

o.r. = of reading

Additional error, in relation to the span of 16 mA:

| | |
|---|-------------|
| Temperature coefficient at zero point (4 mA) | 0.02 %/10 K |
| Temperature coefficient with span (20 mA) | 0.05 %/10 K |

Pulse/frequency output

o.r. = of reading

| | |
|--------------------------------|--------------------|
| Temperature coefficient | Max. ±100 ppm o.r. |
|--------------------------------|--------------------|

Installation

No special measures such as supports are necessary. External forces are absorbed by the construction of the device.

Mounting location

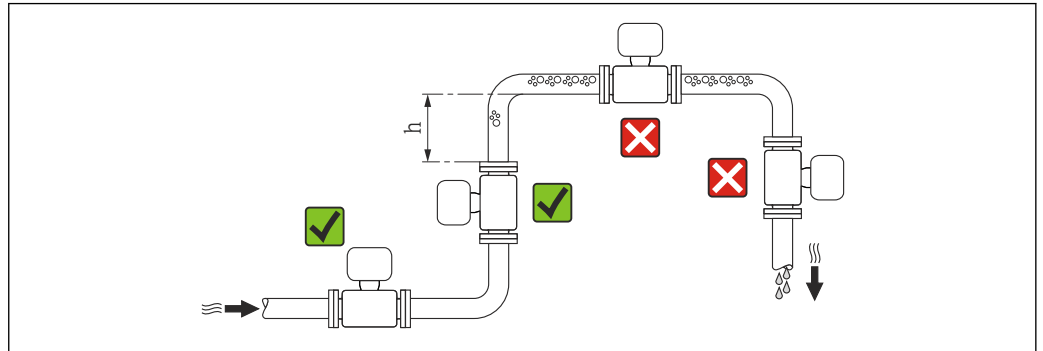

A0023343

Preferably install the sensor in an ascending pipe, and ensure a sufficient distance to the next pipe elbow: $h \geq 2 \times DN$

To prevent measuring errors arising from accumulation of gas bubbles in the measuring tube, avoid the following mounting locations in the pipe:

- Highest point of a pipeline.
- Directly upstream of a free pipe outlet in a down pipe.

Installation in down pipes

Install a siphon with a vent valve downstream of the sensor in down pipes whose length $h \geq 5$ m (16.4 ft). This precaution is to avoid low pressure and the consequent risk of damage to the measuring tube. This measure also prevents the system losing prime.

 For information on the liner's resistance to partial vacuum

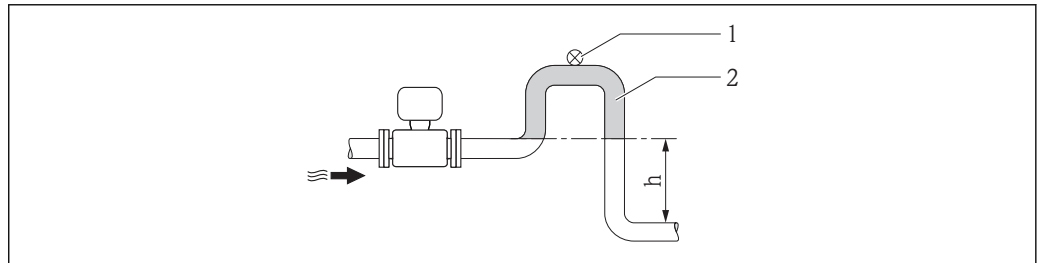

A0017064

 11 Installation in a down pipe

- 1 Vent valve
- 2 Pipe siphon
- h Length of down pipe

Installation in partially filled pipes

A partially filled pipe with a gradient necessitates a drain-type configuration. The empty pipe detection (EPD) function offers additional protection by detecting empty or partially filled pipes.

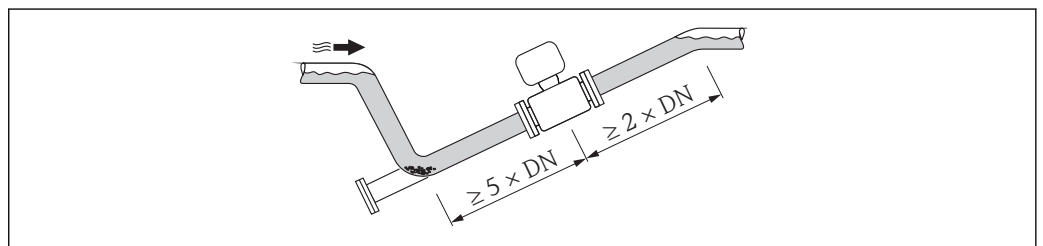

A0017063

Orientation

The direction of the arrow on the sensor nameplate helps you to install the sensor according to the flow direction (direction of medium flow through the piping).

An optimum orientation position helps avoid gas and air accumulations and deposits in the measuring tube.

The measuring device also offers the empty pipe detection function to detect partially filled measuring pipes in the event of outgassing fluids or variable process pressures.

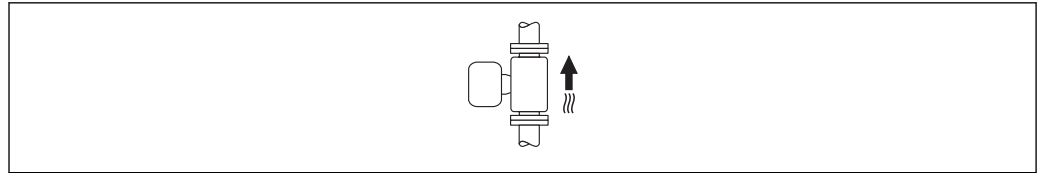
Vertical

A0015591

Optimum for self-emptying pipe systems and for use in conjunction with empty pipe detection.

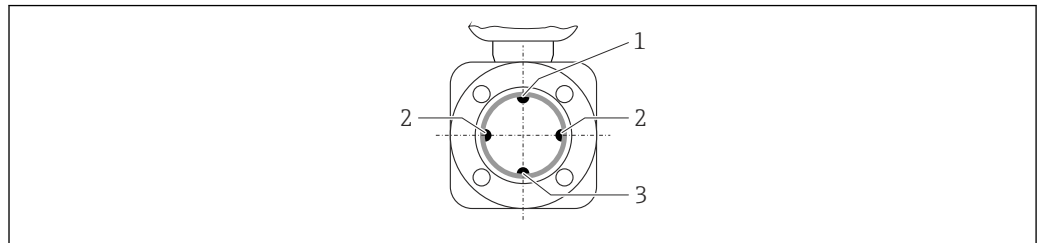
Horizontal

A0016260

- 1 EPD electrode for empty pipe detection
- 2 Measuring electrodes for signal detection
- 3 Reference electrode for potential equalization

- i
 - The measuring electrode plane must be horizontal. This prevents brief insulation of the two measuring electrodes by entrained air bubbles.
 - Empty pipe detection only works if the transmitter housing is pointing upwards as otherwise there is no guarantee that the empty pipe detection function will actually respond to a partially filled or empty measuring tube.

Inlet and outlet runs

If possible, install the sensor upstream from fittings such as valves, T-pieces or elbows.

Observe the following inlet and outlet runs to comply with accuracy specifications:

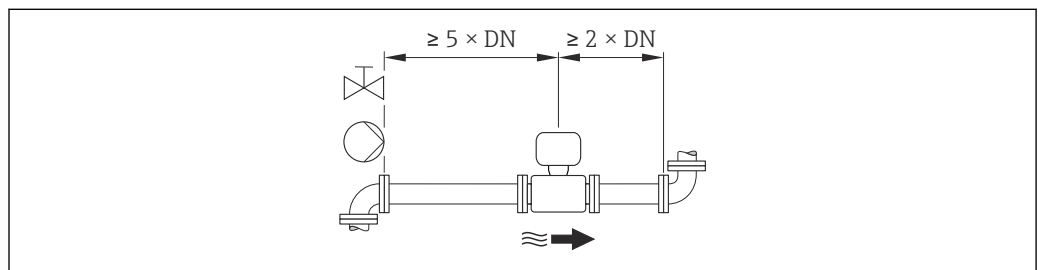

A0016275

Adapters

Suitable adapters to DIN EN 545 (double-flange reducers) can be used to install the sensor in larger-diameter pipes. The resultant increase in the rate of flow improves measuring accuracy with very slow-moving fluids.

The nomogram shown here can be used to calculate the pressure loss caused by reducers and expanders:

- Calculate the ratio of the diameters d/D .
- From the nomogram read off the pressure loss as a function of flow velocity (downstream from the reduction) and the d/D ratio.

i The nomogram only applies to liquids with a viscosity similar to that of water.

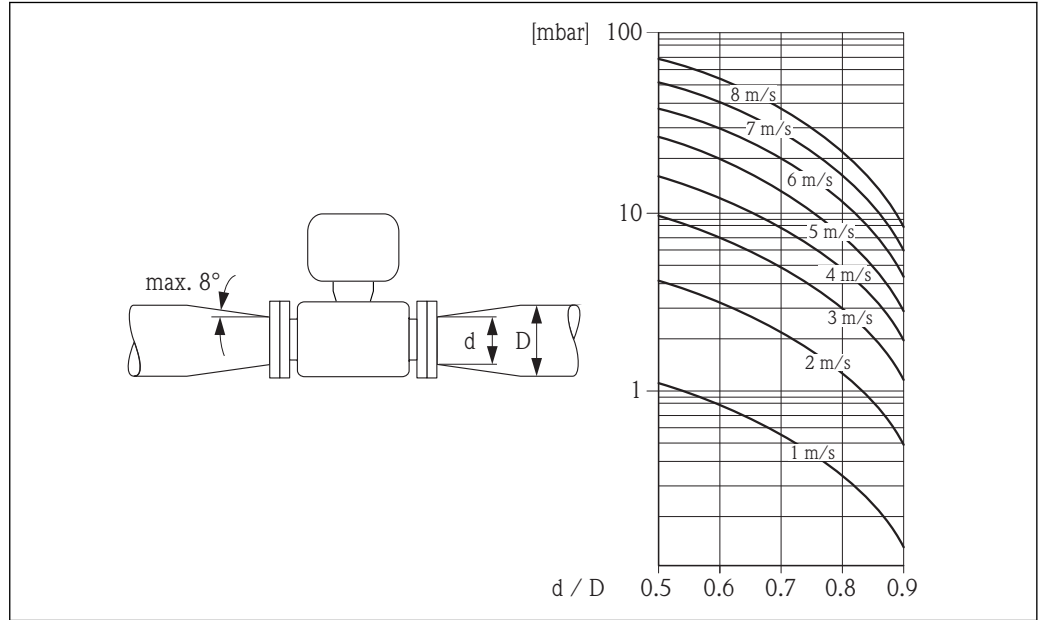

A0016359

Special mounting instructions

Display protection

To ensure that the optional display protection can be easily opened, maintain the following minimum head clearance: 350 mm (13.8 in)

Environment

Ambient temperature range

| | |
|---------------|---|
| Transmitter | -40 to +60 °C (-40 to +140 °F) |
| Local display | -20 to +60 °C (-4 to +140 °F), the readability of the display may be impaired at temperatures outside the temperature range. |
| Sensor | <ul style="list-style-type: none"> ■ Process connection material, carbon steel: -10 to +60 °C (+14 to +140 °F) ■ Process connection material, stainless steel: -40 to +60 °C (-40 to +140 °F) |
| Liner | Do not exceed or fall below the permitted temperature range of the liner . |

If operating outdoors:

- Install the measuring device in a shady location.
- Avoid direct sunlight, particularly in warm climatic regions.
- Avoid direct exposure to weather conditions.

i Weather protection covers can be ordered from Endress+Hauser: see "Accessories" section → 48

Temperature tables

The following interdependencies between the permitted ambient and fluid temperatures apply when operating the device in hazardous areas:

NOTICE**The ambient temperature changes for installations with overvoltage protection in conjunction with temperature classes T5 and T6.**

The following applies for basic specification, position 1, 2 (approval) = BJ, B5, BH, IJ, I6, IH, C2, NF, N6, NH, NK, MJ:

- ▶ $T_a = T_a - 2 \text{ K}$

SI units

| T_a [°C] | T6 [85 °C] | T5 [100 °C] | T4 [135 °C] | T3 [200 °C] | T2 [300 °C] | T1 [450 °C] |
|------------------|---------------|----------------|----------------|----------------|----------------|----------------|
| 40 | 80 | 95 | 130 | 150 | 150 | 150 |
| 55 | – | 95 | 130 | 150 | 150 | 150 |
| 60 ¹⁾ | – | 95 | 130 | 150 | 150 | 150 |

- 1) The following applies for Basic specification, Position 3 (Output) = A, B, E, G: $P_1 = 0.85 \text{ W}$

US units

| T_a [°F] | T6 [185 °F] | T5 [212 °F] | T4 [275 °F] | T3 [392 °F] | T2 [572 °F] | T1 [842 °F] |
|-------------------|----------------|----------------|----------------|----------------|----------------|----------------|
| 104 | 176 | 203 | 266 | 302 | 302 | 302 |
| 131 | – | 203 | 266 | 302 | 302 | 302 |
| 140 ¹⁾ | – | 203 | 266 | 302 | 302 | 302 |

- 1) The following applies for basic specification, position 3 (output) = A, B, E, G: $P_1 = 0.85 \text{ W}$

Storage temperature

The storage temperature corresponds to the operating temperature range of the measuring transmitter and the appropriate measuring sensors.

- Protect the measuring device against direct sunlight during storage in order to avoid unacceptably high surface temperatures.
- Select a storage location where moisture cannot collect in the measuring device as fungus or bacteria infestation can damage the liner.
- If protection caps or protective covers are mounted these should never be removed before installing the measuring device.

Degree of protection**Transmitter**

- As standard: IP66/67, type 4X enclosure
- When housing is open: IP20, type 1 enclosure
- Display module: IP20, type 1 enclosure

Sensor

IP66/67, type 4X enclosure

Connector

IP67, only in screwed situation

Shock resistance

As per IEC/EN 60068-2-31

Vibration resistance

Acceleration up to 2 g, according to IEC 60068-2-6

Mechanical load

- Protect the transmitter housing against mechanical effects, such as shock or impact.
- Never use the transmitter housing as a ladder or climbing aid.

Electromagnetic compatibility (EMC)

As per IEC/EN 61326 and NAMUR Recommendation 21 (NE 21)



For details, refer to the Declaration of Conformity.

Process

- Medium temperature range**
- -20 to +150 °C (-4 to +302 °F) for PFA
 - -40 to +130 °C (-40 to +266 °F) for PTFE

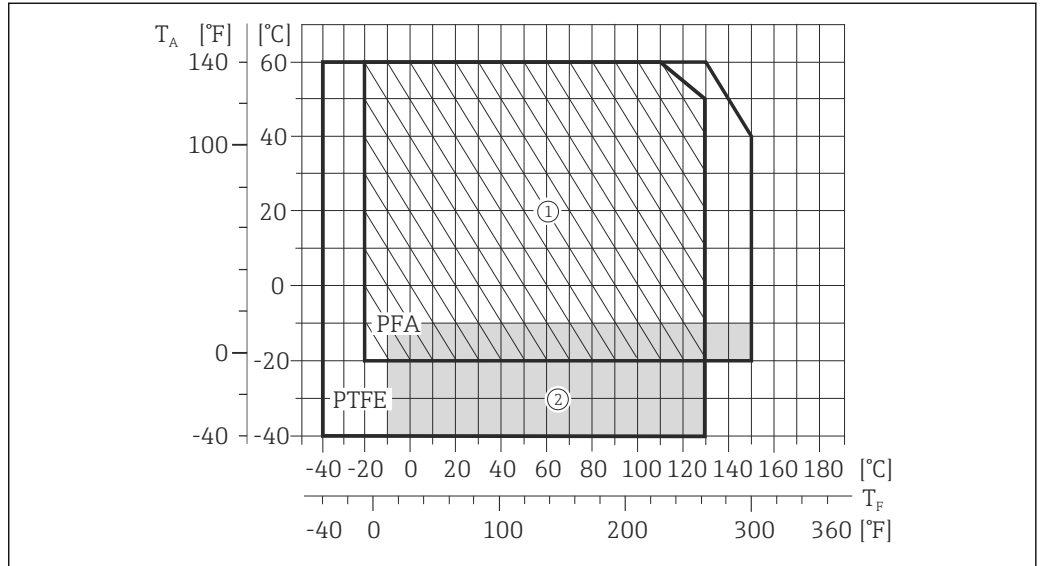

A0017724

T_A Ambient temperature

T_F Medium temperature

1 Hatched area: harsh environment only up to +130 °C (+266 °F)

2 Gray area: the ambient and fluid temperature range of -10 to -40 °C (-14 to -40 °F) applies to stainless flanges only

Conductivity $\geq 20 \mu\text{S/cm}$ for liquids in general

Pressure-temperature ratings The following pressure-temperature ratings refer to the entire device and not just the process connection.

Process connection: flange according to EN 1092-1 (DIN 2501)

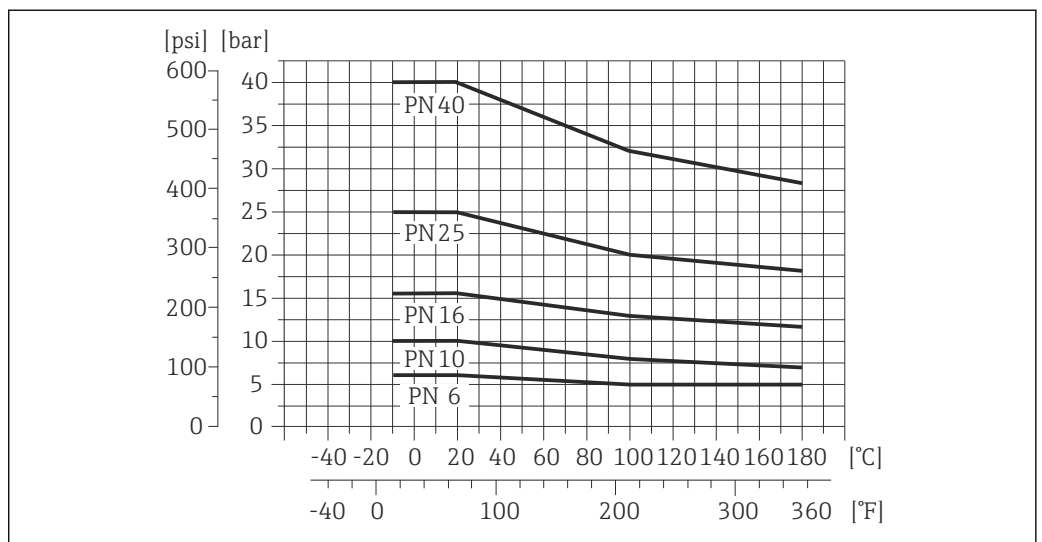

A0021188-EN

12 Process connection material: carbon steel, FE410WB/S235JRG2; Alloy C22, 2.4602 (UNS N06022)

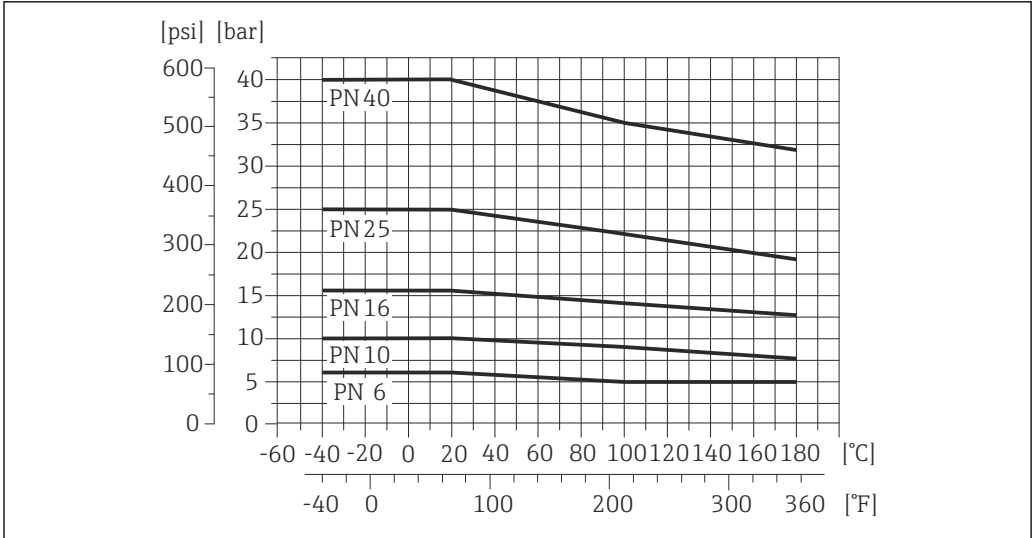

13 Process connection material: stainless steel, 1.4571 (F316L)

Process connection: flange according to ASME B16.5

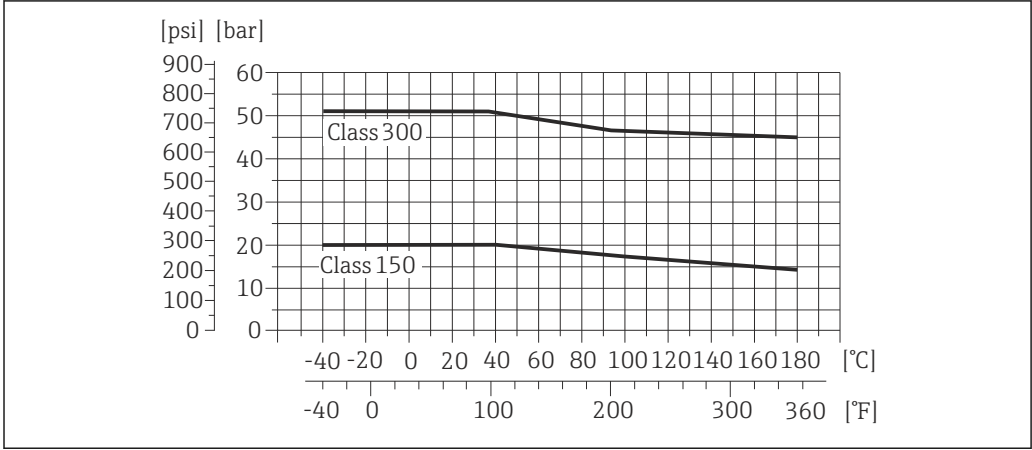

14 Process connection material: carbon steel, A105

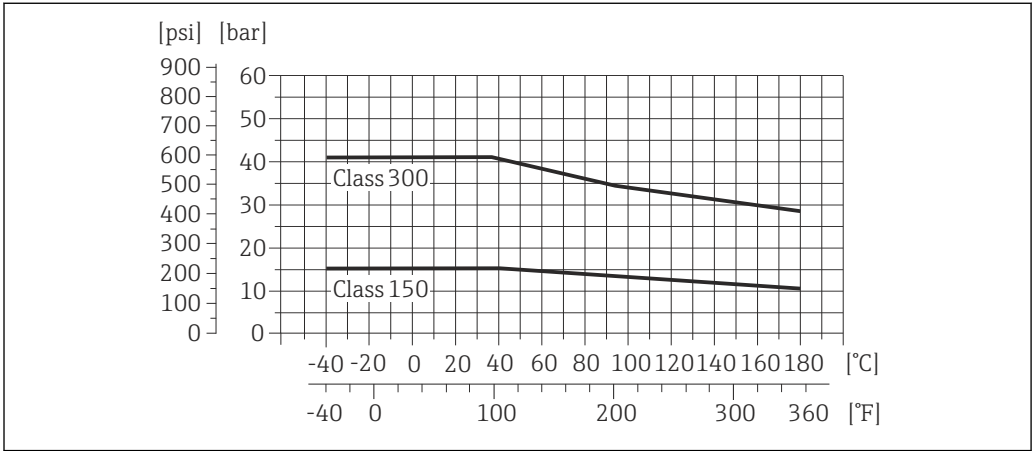

15 Process connection material: stainless steel, F316L

Process connection: flange according to JIS B2220

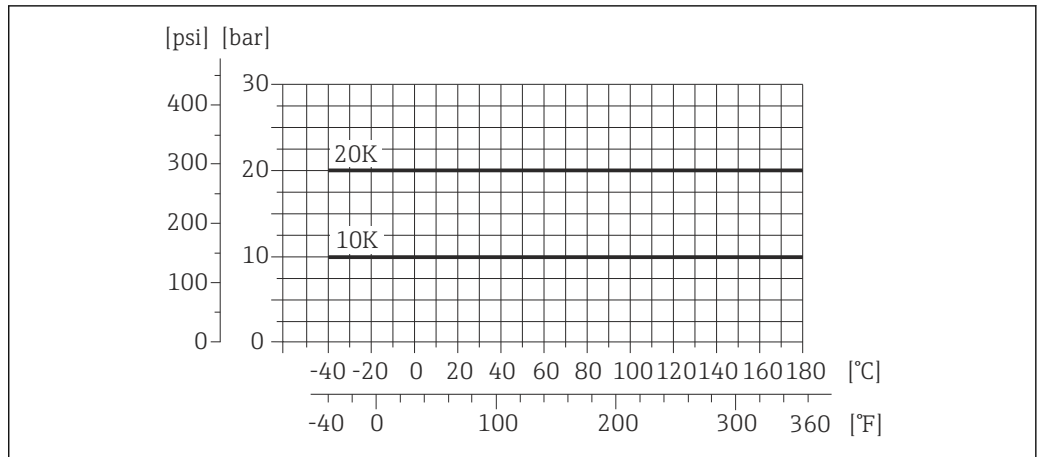

A0021183-EN

16 Process connection material: stainless steel, 1.0425 (F316L); carbon steel, S235JRG2/HII

Pressure tightness

"-" = no specifications possible

Liner: PFA

| Nominal diameter | | Limit values for absolute pressure in [mbar] ([psi]) for fluid temperatures: | | |
|------------------|------|--|------------------|-----------------------------------|
| [mm] | [in] | +25 °C (+77 °F) | +80 °C (+176 °F) | +100 to +180 °C (+212 to +356 °F) |
| 25 | 1 | 0 (0) | 0 (0) | 0 (0) |
| 32 | - | 0 (0) | 0 (0) | 0 (0) |
| 40 | 1 ½ | 0 (0) | 0 (0) | 0 (0) |
| 50 | 2 | 0 (0) | 0 (0) | 0 (0) |
| 65 | - | 0 (0) | - | 0 (0) |
| 80 | 3 | 0 (0) | - | 0 (0) |
| 100 | 4 | 0 (0) | - | 0 (0) |
| 125 | - | 0 (0) | - | 0 (0) |
| 150 | 6 | 0 (0) | - | 0 (0) |
| 200 | 8 | 0 (0) | - | 0 (0) |

Liner: PTFE

| Nominal diameter | | Limit values for absolute pressure in [mbar] ([psi]) for fluid temperatures: | | | |
|------------------|------|--|------------------|-------------------|-------------------|
| [mm] | [in] | +25 °C (+77 °F) | +80 °C (+176 °F) | +100 °C (+212 °F) | +130 °C (+266 °F) |
| 15 | ½ | 0 (0) | 0 (0) | 0 (0) | 100 (1.45) |
| 25 | 1 | 0 (0) | 0 (0) | 0 (0) | 100 (1.45) |
| 32 | - | 0 (0) | 0 (0) | 0 (0) | 100 (1.45) |
| 40 | 1 ½ | 0 (0) | 0 (0) | 0 (0) | 100 (1.45) |
| 50 | 2 | 0 (0) | 0 (0) | 0 (0) | 100 (1.45) |
| 65 | - | 0 (0) | - | 40 (0.58) | 130 (1.89) |
| 80 | 3 | 0 (0) | - | 40 (0.58) | 130 (1.89) |
| 100 | 4 | 0 (0) | - | 135 (1.96) | 170 (2.47) |
| 125 | - | 135 (1.96) | - | 240 (3.48) | 385 (5.58) |
| 150 | 6 | 135 (1.96) | - | 240 (3.48) | 385 (5.58) |
| 200 | 8 | 200 (2.90) | - | 290 (4.21) | 410 (5.95) |

Flow limit

The diameter of the pipe and the flow rate determine the nominal diameter of the sensor. The optimum velocity of flow is between 2 to 3 m/s (6.56 to 9.84 ft/s). Also match the velocity of flow (v) to the physical properties of the fluid:

- $v < 2$ m/s (6.56 ft/s): for abrasive fluids (e.g. potter's clay, lime milk, ore slurry)
- $v > 2$ m/s (6.56 ft/s): for fluids producing buildup (e.g. wastewater sludges)

i A necessary increase in the flow velocity can be achieved by reducing the sensor nominal diameter.

i For an overview of the measuring range full scale values, see the "Measuring range" section → 5

Pressure loss

- No pressure loss occurs if the sensor is installed in a pipe with the same nominal diameter.
- Pressure losses for configurations incorporating adapters according to DIN EN 545 → 28

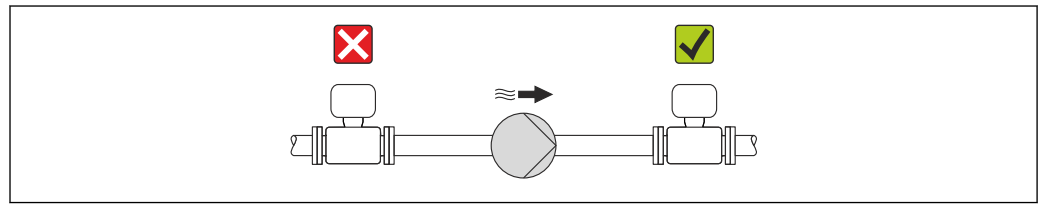
System pressure

A0015594

Never install the sensor on the pump suction side in order to avoid the risk of low pressure, and thus damage to the liner.

i Furthermore, install pulse dampers if reciprocating, diaphragm or peristaltic pumps are used.

- For information on the liner's resistance to partial vacuum → 33
- For information on the shock resistance of the measuring system → 30
- For information on the vibration resistance of the measuring system → 30

Vibrations

In the event of very strong vibrations, the pipe and sensor must be supported and fixed.

- For information on the shock resistance of the measuring system → 30
- For information on the vibration resistance of the measuring system → 30

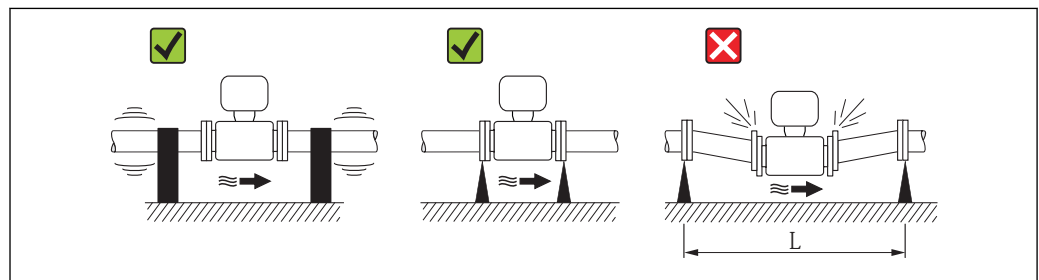

A0016266

17 Measures to avoid device vibrations ($L > 10$ m (33 ft))

Mechanical construction

Dimensions in SI units

Compact version

Order code for "Housing", option C "GT20 two-chamber, aluminum coated"

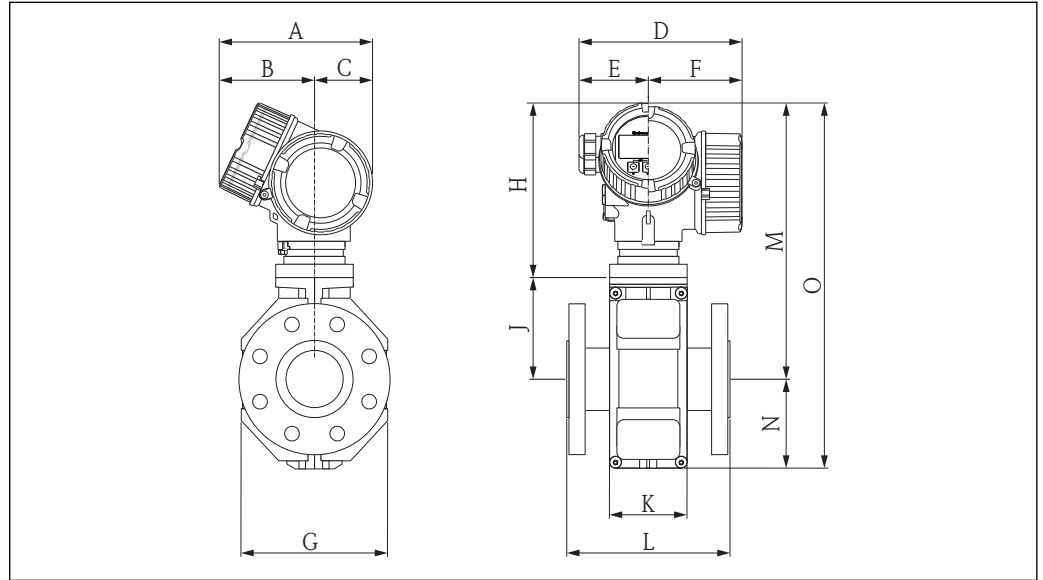

A0017644

| DN | L ¹⁾ | A | B ²⁾ | C | D ³⁾ | E | F ³⁾ | G | H | J | K | M ⁴⁾ | N | O ⁴⁾ |
|------|-----------------|------|-----------------|------|-----------------|------|-----------------|------|------|------|------|-----------------|------|-----------------|
| [mm] | [mm] | [mm] | [mm] | [mm] | [mm] | [mm] | [mm] | [mm] | [mm] | [mm] | [mm] | [mm] | [mm] | [mm] |
| 15 | 200 | 162 | 102 | 60 | 165 | 75 | 90 | 120 | 190 | 90 | 94 | 280 | 84 | 364 |
| 25 | 200 | 162 | 102 | 60 | 165 | 75 | 90 | 120 | 190 | 90 | 94 | 280 | 84 | 364 |
| 32 | 200 | 162 | 102 | 60 | 165 | 75 | 90 | 120 | 190 | 90 | 94 | 280 | 84 | 364 |
| 40 | 200 | 162 | 102 | 60 | 165 | 75 | 90 | 120 | 190 | 90 | 94 | 280 | 84 | 364 |
| 50 | 200 | 162 | 102 | 60 | 165 | 75 | 90 | 120 | 190 | 90 | 94 | 280 | 84 | 364 |
| 65 | 200 | 162 | 102 | 60 | 165 | 75 | 90 | 180 | 190 | 115 | 94 | 305 | 109 | 414 |
| 80 | 200 | 162 | 102 | 60 | 165 | 75 | 90 | 180 | 190 | 115 | 94 | 305 | 109 | 414 |
| 100 | 250 | 162 | 102 | 60 | 165 | 75 | 90 | 180 | 190 | 115 | 94 | 305 | 109 | 414 |
| 125 | 250 | 162 | 102 | 60 | 165 | 75 | 90 | 260 | 190 | 155 | 140 | 345 | 150 | 495 |
| 150 | 300 | 162 | 102 | 60 | 165 | 75 | 90 | 260 | 190 | 155 | 140 | 345 | 150 | 495 |
| 200 | 350 | 162 | 102 | 60 | 165 | 75 | 90 | 324 | 190 | 180 | 156 | 370 | 180 | 550 |

- 1) The length (L) is always the same, irrespective of the selected pressure rating.
- 2) For version without local display: values - 7 mm
- 3) For version with overvoltage protection (OVP): values + 8 mm
- 4) For version without local display: values - 10 mm

Accessories

Ground disk for flange connection

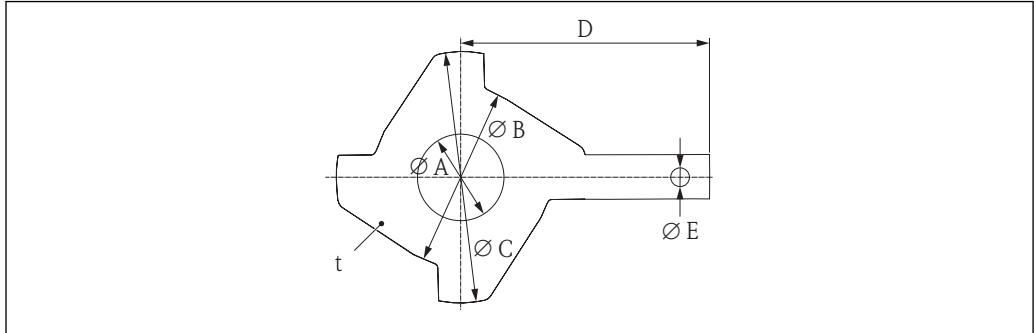

| DN [mm] | A [mm] | B [mm] | C [mm] | D [mm] | E [mm] | t [mm] |
|------------|-----------|-----------|-----------|-----------|-----------|-----------|
| 15 | 16 | 43 | 61.5 | 73 | 6.5 | 2 |
| 25 | 26 | 62 | 77.5 | 87.5 | 6.5 | 2 |
| 32 | 35 | 80 | 87.5 | 94.5 | 6.5 | 2 |
| 40 | 41 | 82 | 101 | 103 | 6.5 | 2 |
| 50 | 52 | 101 | 115.5 | 108 | 6.5 | 2 |
| 65 | 68 | 121 | 131.5 | 118 | 6.5 | 2 |
| 80 | 80 | 131 | 154.5 | 135 | 6.5 | 2 |
| 100 | 104 | 156 | 186.5 | 153 | 6.5 | 2 |
| 125 | 130 | 187 | 206.5 | 160 | 6.5 | 2 |
| 150 | 158 | 217 | 256 | 184 | 6.5 | 2 |
| 200 | 206 | 267 | 288 | 205 | 6.5 | 2 |

Dimensions in US units

Compact version

Order code for "Housing", option C "GT20 two-chamber, aluminum coated"

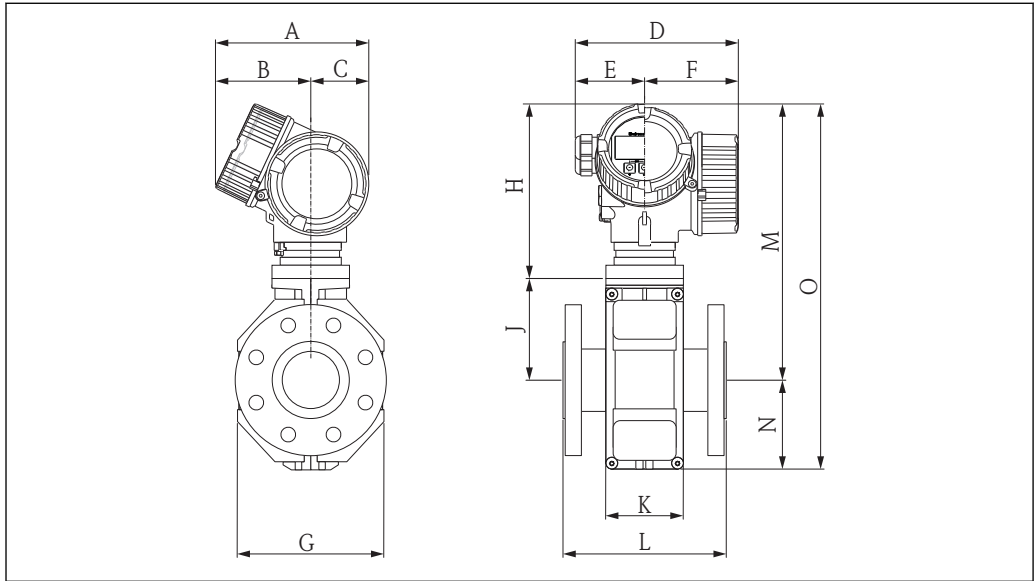

| DN | L ¹⁾ | A | B ²⁾ | C | D ³⁾ | E | F ³⁾ | G | H | J | K | M ⁴⁾ | N | O ⁴⁾ |
|------|-----------------|------|-----------------|------|-----------------|------|-----------------|------|------|------|------|-----------------|------|-----------------|
| [in] | [in] | [in] | [in] | [in] | [in] | [in] | [in] | [in] | [in] | [in] | [in] | [in] | [in] | [in] |
| ½ | 7.87 | 6.38 | 4.02 | 2.36 | 6.50 | 2.95 | 3.54 | 4.72 | 7.46 | 3.54 | 3.7 | 11.0 | 3.31 | 14.3 |
| 1 | 7.87 | 6.38 | 4.02 | 2.36 | 6.50 | 2.95 | 3.54 | 4.72 | 7.46 | 3.54 | 3.7 | 11.0 | 3.31 | 14.3 |
| 1 ¼ | 7.87 | 6.38 | 4.02 | 2.36 | 6.50 | 2.95 | 3.54 | 4.72 | 7.46 | 3.54 | 3.7 | 11.0 | 3.31 | 14.3 |
| 1 ½ | 7.87 | 6.38 | 4.02 | 2.36 | 6.50 | 2.95 | 3.54 | 4.72 | 7.46 | 3.54 | 3.7 | 11.0 | 3.31 | 14.3 |
| 2 | 7.87 | 6.38 | 4.02 | 2.36 | 6.50 | 2.95 | 3.54 | 4.72 | 7.46 | 3.54 | 3.7 | 11.0 | 3.31 | 14.3 |
| 2 ½ | 7.87 | 6.38 | 4.02 | 2.36 | 6.50 | 2.95 | 3.54 | 7.09 | 7.46 | 4.53 | 3.7 | 12.0 | 4.29 | 16.3 |
| 3 | 7.87 | 6.38 | 4.02 | 2.36 | 6.50 | 2.95 | 3.54 | 7.09 | 7.46 | 4.53 | 3.7 | 12.0 | 4.29 | 16.3 |
| 4 | 9.84 | 6.38 | 4.02 | 2.36 | 6.50 | 2.95 | 3.54 | 7.09 | 7.46 | 4.53 | 3.7 | 12.0 | 4.29 | 16.3 |
| 5 | 9.84 | 6.38 | 4.02 | 2.36 | 6.50 | 2.95 | 3.54 | 10.2 | 7.46 | 6.10 | 5.51 | 13.6 | 5.91 | 19.5 |
| 6 | 11.8 | 6.38 | 4.02 | 2.36 | 6.50 | 2.95 | 3.54 | 10.2 | 7.46 | 6.10 | 5.51 | 13.6 | 5.91 | 19.5 |
| 8 | 13.8 | 6.38 | 4.02 | 2.36 | 6.50 | 2.95 | 3.54 | 12.8 | 7.46 | 7.09 | 6.14 | 14.6 | 7.09 | 21.7 |

- 1) The length (L) is always the same, irrespective of the selected pressure rating.
- 2) For version without local display: values - 0.28 in
- 3) For version with overvoltage protection (OVP): values + 0.31 in
- 4) For version without local display: values - 0.39 in

Accessories

Ground disk for flange connection

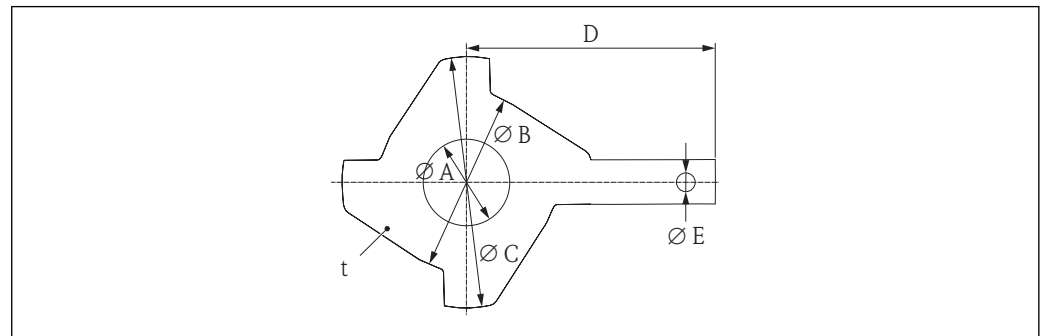

A0017649

| DN | A | B | C | D | E | t |
|------|------|------|------|------|------|------|
| [in] | [in] | [in] | [in] | [in] | [in] | [in] |
| ½ | 0.63 | 1.69 | 2.42 | 2.87 | 0.26 | 0.08 |
| 1 | 1.02 | 2.44 | 3.05 | 3.44 | 0.26 | 0.08 |
| 1 ¼ | 1.38 | 3.15 | 3.44 | 3.72 | 0.26 | 0.08 |
| 1 ½ | 1.61 | 3.23 | 3.98 | 4.06 | 0.26 | 0.08 |
| 2 | 2.05 | 3.98 | 4.55 | 4.25 | 0.26 | 0.08 |
| 2 ½ | 2.68 | 4.76 | 5.18 | 4.65 | 0.26 | 0.08 |
| 3 | 3.15 | 5.16 | 6.08 | 5.31 | 0.26 | 0.08 |
| 4 | 4.09 | 6.14 | 7.34 | 6.02 | 0.26 | 0.08 |
| 5 | 5.12 | 7.36 | 8.13 | 6.30 | 0.26 | 0.08 |
| 6 | 6.22 | 8.54 | 10.1 | 7.24 | 0.26 | 0.08 |
| 8 | 8.11 | 10.5 | 11.3 | 8.07 | 0.26 | 0.08 |

Weight**Compact version**

- Including the transmitter (1.9 kg (4.2 lbs))
- Weight specifications apply to standard pressure ratings and without packaging material.

Weight in SI units

| Nominal diameter | | EN (DIN), AS ¹⁾ | | ASME | | JIS | |
|------------------|------|----------------------------|------|-----------------|------|-----------------|------|
| [mm] | [in] | Pressure rating | [kg] | Pressure rating | [kg] | Pressure rating | [kg] |
| 15 | ½ | PN 40 | 5.0 | Class 150 | 5.0 | 10K | 5.0 |
| 25 | 1 | PN 40 | 5.8 | Class 150 | 5.8 | 10K | 5.8 |
| 32 | 1 ¼ | PN 40 | 6.5 | Class 150 | – | 10K | 5.8 |
| 40 | 1 ½ | PN 40 | 7.9 | Class 150 | 7.9 | 10K | 6.8 |
| 50 | 2 | PN 40 | 9.1 | Class 150 | 9.1 | 10K | 7.8 |
| 65 | 2 ½ | PN 16 | 10.5 | Class 150 | – | 10K | 9.6 |
| 80 | 3 | PN 16 | 12.5 | Class 150 | 12.5 | 10K | 11.0 |
| 100 | 4 | PN 16 | 14.5 | Class 150 | 14.5 | 10K | 13.2 |
| 125 | 5 | PN 16 | 20.0 | Class 150 | – | 10K | 19.5 |
| 150 | 6 | PN 16 | 24.0 | Class 150 | 24.0 | 10K | 23.0 |
| 200 | 8 | PN 10 | 43.5 | Class 150 | 43.5 | 10K | 40.4 |

1) For flanges to AS, only DN 25 and 50 are available.

Weight in US units

| Nominal diameter | | ASME | |
|------------------|------|-----------------|-------|
| [mm] | [in] | Pressure rating | [lbs] |
| 15 | ½ | Class 150 | 11.0 |
| 25 | 1 | Class 150 | 12.8 |
| 32 | 1 ¼ | Class 150 | – |
| 40 | 1 ½ | Class 150 | 17.4 |
| 50 | 2 | Class 150 | 20.1 |
| 65 | 2 ½ | Class 150 | – |
| 80 | 3 | Class 150 | 27.6 |
| 100 | 4 | Class 150 | 32.0 |
| 125 | 5 | Class 150 | – |
| 150 | 6 | Class 150 | 52.9 |
| 200 | 8 | Class 150 | 95.9 |

Measuring tube specification

| Nominal diameter | | Pressure rating | | | | | Process connection internal diameter | | | |
|------------------|------|-----------------|-----------|---------|---------|-------|--------------------------------------|------|------|------|
| | | EN (DIN) | ASME | AS 2129 | AS 4087 | JIS | PFA | | PTFE | |
| [mm] | [in] | [bar] | [psi] | [bar] | [bar] | [bar] | [mm] | [in] | [mm] | [in] |
| 15 | ½ | PN 40 | Class 150 | – | – | 20K | – | – | 15 | 0.59 |
| 25 | 1 | PN 40 | Class 150 | Table E | – | 20K | 23 | 0.91 | 26 | 1.02 |
| 32 | – | PN 40 | – | – | – | 20K | 32 | 1.26 | 35 | 1.38 |
| 40 | 1 ½ | PN 40 | Class 150 | – | – | 20K | 36 | 1.42 | 41 | 1.61 |

| Nominal diameter | | Pressure rating | | | | | Process connection internal diameter | | | |
|------------------|------|-----------------|-----------|---------|---------|-------|--------------------------------------|------|------|------|
| | | EN (DIN) | ASME | AS 2129 | AS 4087 | JIS | PFA | | PTFE | |
| [mm] | [in] | [bar] | [psi] | [bar] | [bar] | [bar] | [mm] | [in] | [mm] | [in] |
| 50 | 2 | PN 40 | Class 150 | Table E | PN 16 | 10K | 48 | 1.89 | 52 | 2.05 |
| 65 | - | PN 16 | - | - | - | 10K | 63 | 2.48 | 67 | 2.64 |
| 80 | 3 | PN 16 | Class 150 | - | - | 10K | 75 | 2.95 | 80 | 3.15 |
| 100 | 4 | PN 16 | Class 150 | - | - | 10K | 101 | 3.98 | 104 | 4.09 |
| 125 | - | PN 16 | - | - | - | 10K | 126 | 4.96 | 129 | 5.08 |
| 150 | 6 | PN 16 | Class 150 | - | - | 10K | 154 | 6.06 | 156 | 6.14 |
| 200 | 8 | PN 10 | Class 150 | - | - | 10K | 201 | 7.91 | 202 | 7.95 |

Materials

Transmitter housing

- Order code for "Housing", option **C** "Compact, aluminum coated":
Aluminum, AlSi10Mg, coated
- Window material: glass

Cable entries/cable glands

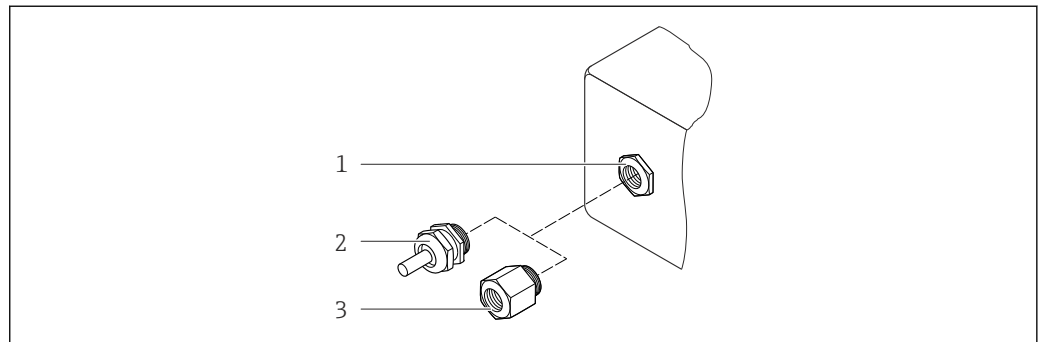

18 Possible cable entries/cable glands

- 1 Cable entry in transmitter housing with internal thread M20 x 1.5
- 2 Cable gland M20 x 1.5
- 3 Adapter for cable entry with internal thread G 1/2" or NPT 1/2"

Order code for "Housing", option C "GT20 two-chamber, aluminum coated"

| Cable entry/cable gland | Type of protection | Material |
|---|--|---------------------|
| Cable gland M20 x 1.5 | <ul style="list-style-type: none"> ■ Non-Ex ■ Ex ia ■ Ex ic | Plastic |
| | Adapter for cable entry with internal thread G 1/2" | Nickel-plated brass |
| Adapter for cable entry with internal thread NPT 1/2" | For non-Ex and Ex (except for CSA Ex d/XP) | Nickel-plated brass |
| Thread NPT 1/2" via adapter | For non-Ex and Ex | |

Device plug

| Electrical connection | Material |
|-----------------------|--|
| Plug M12x1 | <ul style="list-style-type: none"> ▪ Socket: stainless steel, 1.4401/316 ▪ Contact housing: plastic, PUR, black ▪ Contacts: metal, CuZn, gold-plated ▪ Threaded connection seal: NBR |

Sensor housing

Coated aluminum AlSi10Mg

Measuring tubes

Stainless steel, 1.4301/304/1.4306/304L; for flanges made of carbon steel with Al/Zn protective coating

Liner

- PFA
- PTFE

Process connections

EN 1092-1 (DIN 2501)

Stainless steel, 1.4571 (F316L); carbon steel, FE410WB/S235JRG2; Alloy C22, 2.4602 (UNS N06022) (with Al/Zn protective varnish)

ASME B16.5

Stainless steel, F316L; carbon steel, A105 (with Al/Zn protective varnish)

JIS B2220

Stainless steel, 1.0425 (F316L); carbon steel, S235JRG2/HII (with Al/Zn protective varnish)

Electrodes

Stainless steel, 1.4435 (F316L); Alloy C22, 2.4602 (UNS N06022); platinum; tantalum; titanium

Seals

In accordance with DIN EN 1514-1

Accessories*Weather protection cover*

Stainless steel 1.4404 (316L)

Ground disks

Stainless steel, 1.4435 (F316L); Alloy C22, 2.4602 (UNS N06022); tantalum; titanium

Fitted electrodes

Measuring electrodes, reference electrodes and electrodes for empty pipe detection:

- Standard: stainless steel, 1.4435 (F316L); Alloy C22, 2.4602 (UNS N06022); tantalum, titanium
- Optional: only platinum measuring electrodes

Process connections

- EN 1092-1 (DIN 2501); dimensions as per DIN 2501, DN 65 PN 16 only as per EN 1092-1
- ASME B16.5
- JIS B2220
- AS 2129 Table E
- AS 4087 PN 16



For information on the materials of the process connections → 40

Surface roughness

Stainless steel electrodes, 1.4435 (F316L); Alloy C22, 2.4602 (UNS N06022); platinum; tantalum; titanium:

≤ 0.3 to 0.5 μm (11.8 to 19.7 μin)

(All data relate to parts in contact with fluid)

Liner with PFA:
 ≤ 0.4 µm (15.7 µin)
 (All data relate to parts in contact with fluid)

Operability

Operating concept

Operator-oriented menu structure for user-specific tasks

- Commissioning
- Operation
- Diagnostics
- Expert level

Quick and safe commissioning

- Guided menus ("Make-it-run" wizards) for applications
- Menu guidance with brief explanations of the individual parameter functions

Reliable operation

- Operation in the following languages:
 - Via local display:
 - English, German, French, Spanish, Italian, Dutch, Portuguese, Polish, Russian, Swedish, Turkish, Chinese, Japanese, Bahasa (Indonesian), Vietnamese, Czech
 - Via "FieldCare" operating tool:
 - English, German, French, Spanish, Italian, Chinese, Japanese
- Uniform operating philosophy applied to device and operating tools
- If replacing the electronic module, transfer the device configuration via the integrated memory (integrated HistoROM) which contains the process and measuring device data and the event logbook. No need to reconfigure.

Efficient diagnostics increase measurement availability

- Troubleshooting measures can be called up via the device and in the operating tools
- Diverse simulation options, logbook for events that occur and optional line recorder functions

Local operation



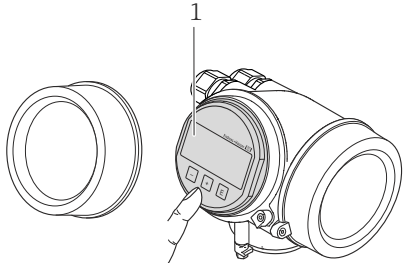
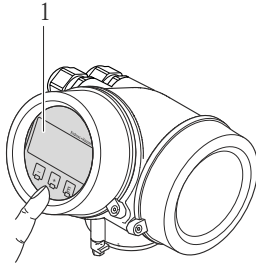



Via display module

| Order code for "Display; Operation", option C "SD02" | Order code for "Display; Operation", option E "SD03" |
|--|--|
|  <p style="text-align: right; font-size: small;">A0015544</p> |  <p style="text-align: right; font-size: small;">A0015546</p> |
| 1 Operation with pushbuttons | 1 Operation with touch control |

Display elements

- 4-line display
- With order code for "Display; operation", option E:
 - White background lighting; switches to red in event of device errors
- Format for displaying measured variables and status variables can be individually configured
- Permitted ambient temperature for the display: -20 to +60 °C (-4 to +140 °F)
 - The readability of the display may be impaired at temperatures outside the temperature range.

Operating elements

- With order code for "Display; operation", option C:
 - Local operation with 3 push buttons:   
- With order code for "Display; operation", option E:
 - External operation via touch control; 3 optical keys:   
- Operating elements also accessible in various hazardous areas

Additional functionality

- Data backup function
The device configuration can be saved in the display module.
- Data comparison function
The device configuration saved in the display module can be compared to the current device configuration.
- Data transfer function
The transmitter configuration can be transmitted to another device using the display module.

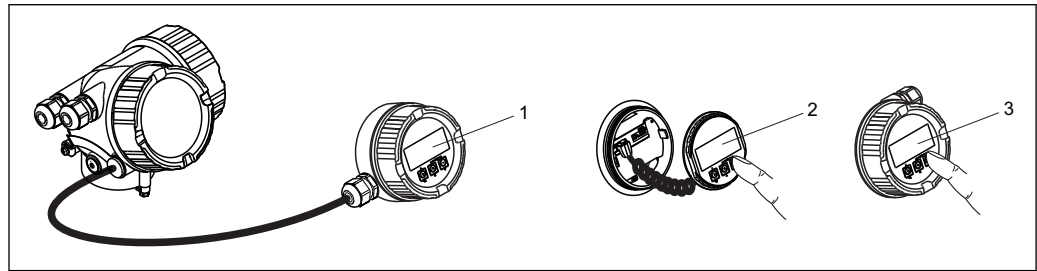
Via remote display and operating module FHX50

A0013137

▣ 19 Operating options via FHX50

- 1 Housing of remote display and operating module FHX50
- 2 SD02 display and operating module, push buttons: cover must be opened for operation
- 3 SD03 display and operating module, optical buttons: operation possible through cover glass

Remote operation**Via HART protocol**

This communication interface is available in device versions with a HART output.

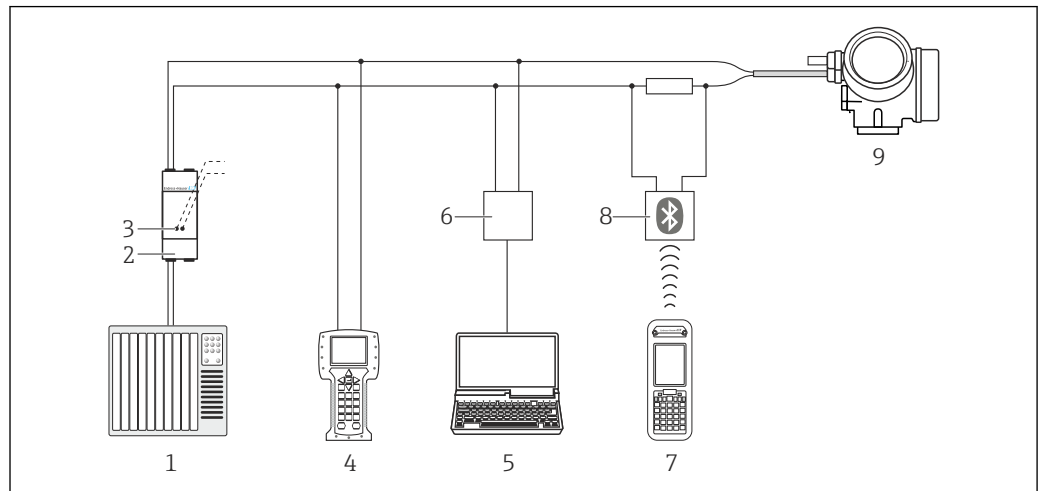

A0013764

▣ 20 Options for remote operation via HART protocol

- 1 Control system (e.g. PLC)
- 2 Transmitter power supply unit, e.g. RN221N (with communication resistor)
- 3 Connection for Commubox FXA195 and Field Communicator 475
- 4 Field Communicator 475
- 5 Computer with operating tool (e.g. FieldCare, AMS Device Manager, SIMATIC PDM)
- 6 Commubox FXA195 (USB)
- 7 Field Xpert SFX350 or SFX370
- 8 VIATOR Bluetooth modem with connecting cable
- 9 Transmitter

Via PROFIBUS PA network

This communication interface is available in device versions with PROFIBUS PA.

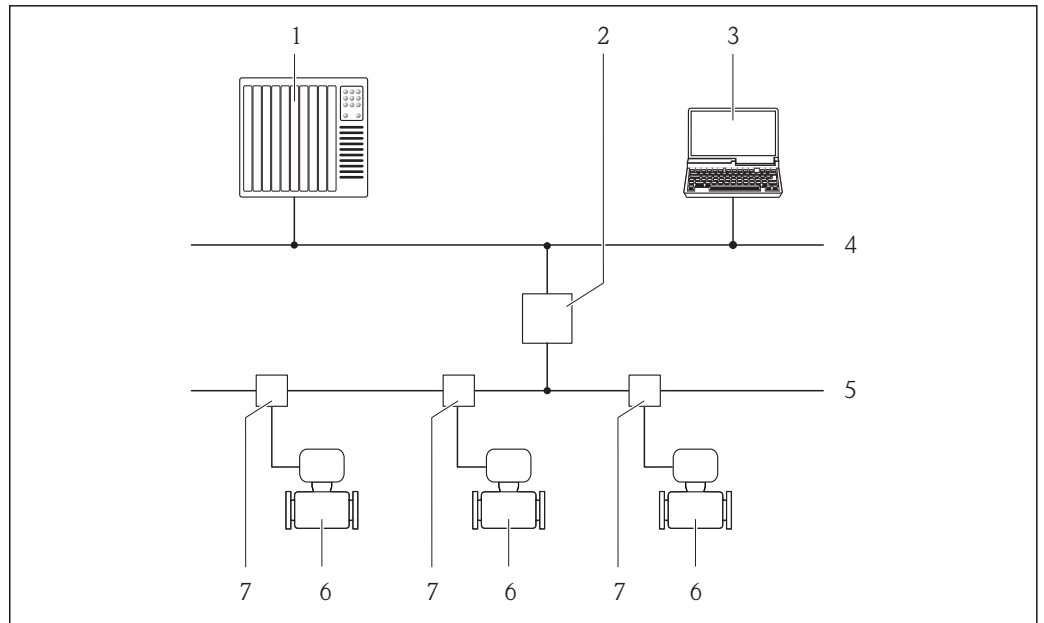

A0019013

21 Options for remote operation via PROFIBUS PA network

- 1 Automation system
- 2 Segment coupler PROFIBUS DP/PA
- 3 Computer with PROFIBUS network card
- 4 PROFIBUS DP network
- 5 PROFIBUS PA network
- 6 Measuring device
- 7 T-box

Via FOUNDATION Fieldbus network

This communication interface is available in device versions with FOUNDATION Fieldbus.

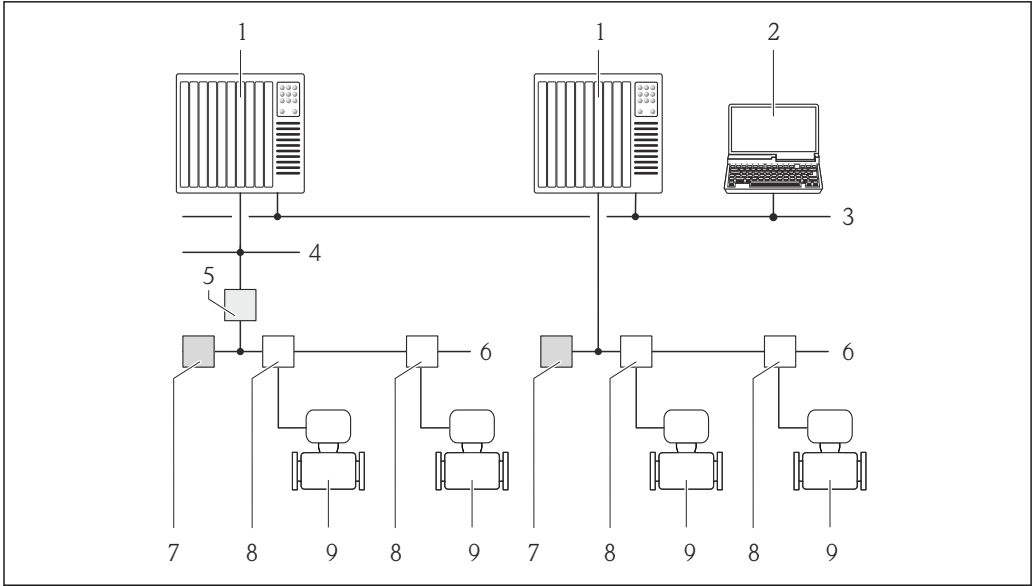

A0023460

22 Options for remote operation via FOUNDATION Fieldbus network

- 1 Automation system
- 2 Computer with FOUNDATION Fieldbus network card
- 3 Industry network
- 4 High Speed Ethernet FF-HSE network
- 5 Segment coupler FF-HSE/FF-H1
- 6 FOUNDATION Fieldbus FF-H1 network
- 7 Power supply FF-H1 network
- 8 T-box
- 9 Measuring device

Service interface

Via service interface (CDI)

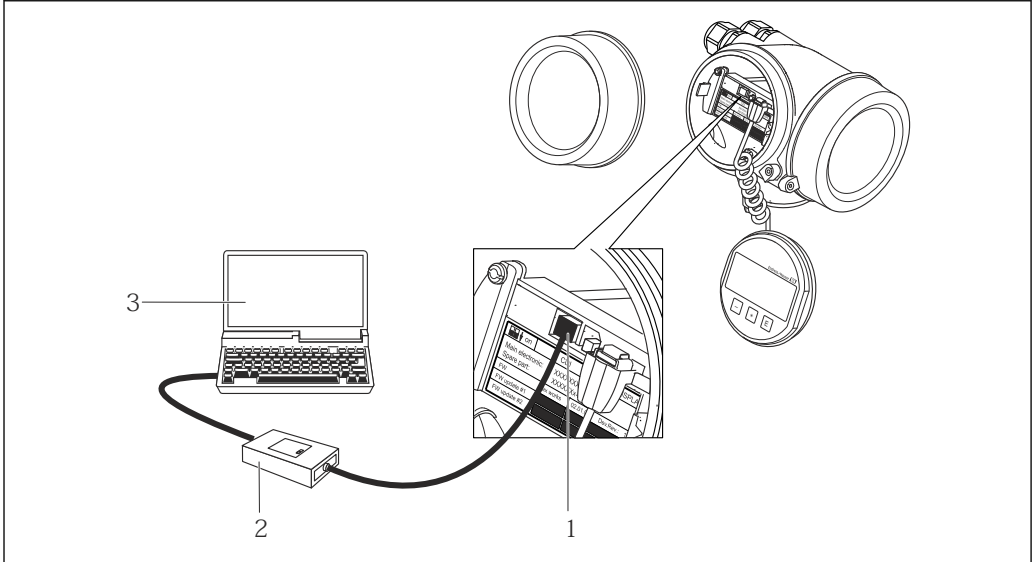

A0014019

- 1 Service interface (CDI = Endress+Hauser Common Data Interface) of the measuring device
- 2 Commubox FXA291
- 3 Computer with "FieldCare" operating tool with COM DTM "CDI Communication FXA291"

Certificates and approvals

CE mark

The measuring system is in conformity with the statutory requirements of the applicable EC Directives. These are listed in the corresponding EC Declaration of Conformity along with the standards applied.

Endress+Hauser confirms successful testing of the device by affixing to it the CE mark.

C-Tick symbol

The measuring system meets the EMC requirements of the "Australian Communications and Media Authority (ACMA)".

Ex approval

The measuring device is certified for use in hazardous areas and the relevant safety instructions are provided in the separate "Safety Instructions" (XA) document. Reference is made to this document on the nameplate.

 The separate Ex documentation (XA) containing all the relevant explosion protection data is available from your Endress+Hauser sales center.

ATEX, IECEx

Currently, the following versions for use in hazardous areas are available:

Ex d

| Category | Type of protection |
|----------------|-----------------------|
| II2G / Zone 1 | Ex d ia IIC T6-T1 Gb |
| II2D / Zone 21 | Ex tb IIIC T** Db |

Ex ia

| Category | Type of protection |
|-----------------|--------------------|
| II2G / Zone 1 | Ex ia IIC T6-T1 Gb |
| III2D / Zone 21 | Ex tb IIIC T** Db |

Ex nA

| Category | Type of protection |
|---------------|--------------------|
| II3G / Zone 2 | Ex nA IIC T6-T1 Gc |

Ex ic

| Category | Type of protection |
|---------------|--------------------|
| II3G / Zone 2 | Ex ic IIC T6-T1 Gc |

cCSAus

Currently, the following versions for use in hazardous areas are available:

XP

| Category | Type of protection |
|--|------------------------------|
| Class I/II/III Division 1 Groups ABCDEFG | XP (Ex d Flameproof version) |

IS

| Category | Type of protection |
|--|--|
| Class I/II/III Division 1 Groups ABCDEFG | IS (Ex i Intrinsically safe version), Entity parameter ¹⁾ |

1) Entity and NIFW parameter in accordance with Control Drawings

NI

| Category | Type of protection |
|--------------------------------|--|
| Class I Division 2 Groups ABCD | NI (Non-incendive version), NIFW parameter ¹⁾ |

1) Entity and NIFW parameter in accordance with Control Drawings

Functional safety

The measuring device can be used for flow monitoring systems (min., max., range) up to SIL 2 (single-channel architecture) and SIL 3 (multichannel architecture with homogeneous redundancy) and is independently evaluated and certified by the TÜV in accordance with IEC 61508.

The following types of monitoring in safety equipment are possible:

Volume flow



Functional Safety Manual with information on the SIL device → 51

HART certification

HART interface

The measuring device is certified and registered by the HCF (HART Communication Foundation). The measuring system meets all the requirements of the following specifications:

- Certified according to HART 7
- The device can also be operated with certified devices of other manufacturers (interoperability)

FOUNDATION Fieldbus certification

FOUNDATION Fieldbus interface

The measuring device is certified and registered by the Fieldbus FOUNDATION. The measuring system meets all the requirements of the following specifications:

- Certified in accordance with FOUNDATION Fieldbus H1
- Interoperability Test Kit (ITK), revision version 6.1.1 (certificate available on request)
- Physical Layer Conformance Test
- The device can also be operated with certified devices of other manufacturers (interoperability)

Certification PROFIBUS

PROFIBUS interface

The measuring device is certified and registered by the PROFIBUS User Organization (PNO). The measuring system meets all the requirements of the following specifications:

- Certified in accordance with PROFIBUS PA Profile 3.02
- The device can also be operated with certified devices of other manufacturers (interoperability)

Other standards and guidelines

- EN 60529
Degrees of protection provided by enclosures (IP code)
- EN 61010-1
Safety requirements for electrical equipment for measurement, control and laboratory use
- IEC/EN 61326
Emission in accordance with Class A requirements. Electromagnetic compatibility (EMC requirements).
- ANSI/ISA-61010-1 (82.02.01): 2004
Safety Requirements for Electrical Equipment for Measurement, Control and Laboratory Use - Part 1 General Requirements
- CAN/CSA-C22.2 No. 61010-1-04
Safety Requirements for Electrical Equipment for Measurement, Control and Laboratory Use - Part 1 General Requirements
- NAMUR NE 21
Electromagnetic compatibility (EMC) of industrial process and laboratory control equipment
- NAMUR NE 32
Data retention in the event of a power failure in field and control instruments with microprocessors
- NAMUR NE 43
Standardization of the signal level for the breakdown information of digital transmitters with analog output signal.
- NAMUR NE 53
Software of field devices and signal-processing devices with digital electronics

- NAMUR NE 105
Specifications for integrating fieldbus devices in engineering tools for field devices
- NAMUR NE 107
Self-monitoring and diagnosis of field devices
- NAMUR NE 131
Requirements for field devices for standard applications

Ordering information

Detailed ordering information is available from the following sources:

- In the Product Configurator on the Endress+Hauser website: www.endress.com → Select your country → Products → Select measuring technology, software or components → Select the product (picklists: measurement method, product family etc.) → Device support (right-hand column): Configure the selected product → The Product Configurator for the selected product opens.
- From your Endress+Hauser Sales Center: www.addresses.endress.com



Product Configurator - the tool for individual product configuration

- Up-to-the-minute configuration data
- Depending on the device: Direct input of measuring point-specific information such as measuring range or operating language
- Automatic verification of exclusion criteria
- Automatic creation of the order code and its breakdown in PDF or Excel output format
- Ability to order directly in the Endress+Hauser Online Shop

Application packages

Many different application packages are available to enhance the functionality of the device. Such packages might be needed to address safety aspects or specific application requirements.

The application packages can be ordered with the device or subsequently from Endress+Hauser. Detailed information on the order code in question is available from your local Endress+Hauser sales center or on the product page of the Endress+Hauser website: www.endress.com.

Diagnostics functions

| Package | Description |
|----------------------------|---|
| HistoROM extended function | <p>Comprises extended functions concerning the event log and the activation of the measured value memory.</p> <p>Event log: Memory volume is extended from 20 message entries (basic version) to up to 100 entries.</p> <p>Data logging (line recorder):</p> <ul style="list-style-type: none"> ■ Memory capacity for up to 1000 measured values is activated. ■ 250 measured values can be output via each of the 4 memory channels. The recording interval can be defined and configured by the user. ■ Data logging is visualized via the local display or FieldCare. |

Heartbeat Technology

| Package | Description |
|------------------------|--|
| Heartbeat Verification | <p>Heartbeat Verification: Makes it possible to check the device functionality on demand when the device is installed, without having to interrupt the process.</p> <ul style="list-style-type: none"> ■ Access via local operation or other operating interfaces, such as FieldCare for instance. ■ Documentation of device functionality within the framework of manufacturer specifications, for proof testing for instance. ■ End-to-end, traceable documentation of the verification results, including report. ■ Makes it possible to extend calibration intervals in accordance with operator's risk assessment. |





Accessories

Various accessories, which can be ordered with the device or subsequently from Endress+Hauser, are available for the device. Detailed information on the order code in question is available from your local Endress+Hauser sales center or on the product page of the Endress+Hauser website:

www.endress.com.

Device-specific accessories









For the transmitter

| Accessories | Description |
|--|--|
| Remote display FHX50 | <p>FHX50 housing to accommodate a display module →  42.</p> <ul style="list-style-type: none"> ■ FHX50 housing suitable for: <ul style="list-style-type: none"> – SD02 display module (push buttons) – SD03 display module (touch control) ■ Housing material: <ul style="list-style-type: none"> – Plastic PBT – Stainless steel CF-3M (316L, 1.4404) ■ Length of connecting cable: up to max. 60 m (196 ft) (cable lengths available for order: 5 m (16 ft), 10 m (32 ft), 20 m (65 ft), 30 m (98 ft)) <p>The measuring device can be ordered with the FHX50 housing and a display module. The following options must be selected in the separate order codes:</p> <ul style="list-style-type: none"> ■ Order code for measuring device, feature 030: Option L or M "Prepared for FHX50 display" ■ Order code for FHX50 housing, feature 050 (device version): Option A "Prepared for FHX50 display" ■ Order code for FHX50 housing, depends on the desired display module in feature 020 (display, operation): <ul style="list-style-type: none"> – Option C: for an SD02 display module (push buttons) – Option E: for an SD03 display module (touch control) <p>The FHX50 housing can also be ordered as a retrofit kit. The measuring device display module is used in the FHX50 housing. The following options must be selected in the order code for the FHX50 housing:</p> <ul style="list-style-type: none"> ■ Feature 050 (measuring device version): option B "Not prepared for FHX50 display" ■ Feature 020 (display, operation): option A "None, existing displayed used" <p> For details, see Special Documentation SD01007F</p> |
| Overvoltage protection for 2-wire devices | <p>Ideally, the overvoltage protection module should be ordered directly with the device. See product structure, characteristic 610 "Accessory mounted", option NA "Overvoltage protection". Separate order necessary only if retrofitting.</p> <ul style="list-style-type: none"> ■ OVP10: For 1-channel devices (characteristic 020, option A): ■ OVP20: For 2-channel devices (characteristic 020, options B, C, E or G) <p> For details, see Special Documentation SD01090F.</p> |
| Weather protection cover | <p>Is used to protect the measuring device from the effects of the weather: e.g. rainwater, excess heating from direct sunlight or extreme cold in winter.</p> <p> For details, see Special Documentation SD00333F</p> |
| Ground cable | Set, consisting of two ground cables for potential equalization. |

For the sensor

| Accessories | Description |
|--------------|---|
| Ground disks | <p>Are used to ground the fluid in lined measuring tubes to ensure proper measurement.</p> <p> For details, see Installation Instructions EA00070D</p> |

Communication-specific accessories



| Accessories | Description |
|-----------------------------|--|
| Commubox FXA195 HART | For intrinsically safe HART communication with FieldCare via the USB interface.  For details, see "Technical Information" TI00404F |
| Commubox FXA291 | Connects Endress+Hauser field devices with a CDI interface (= Endress+Hauser Common Data Interface) and the USB port of a computer or laptop.  For details, see the "Technical Information" document TI405C/07 |
| HART Loop Converter HMX50 | Is used to evaluate and convert dynamic HART process variables to analog current signals or limit values.  For details, see "Technical Information" TI00429F and Operating Instructions BA00371F |
| Wireless HART adapter SWA70 | Is used for the wireless connection of field devices. The WirelessHART adapter can be easily integrated into field devices and existing infrastructures, offers data protection and transmission safety and can be operated in parallel with other wireless networks with minimum cabling complexity.  For details, see Operating Instructions BA00061S |
| Fieldgate FXA320 | Gateway for the remote monitoring of connected 4-20 mA measuring devices via a Web browser.  For details, see "Technical Information" TI00025S and Operating Instructions BA00053S |
| Fieldgate FXA520 | Gateway for the remote diagnostics and remote configuration of connected HART measuring devices via a Web browser.  For details, see "Technical Information" TI00025S and Operating Instructions BA00051S |
| Field Xpert SFX350 | Field Xpert SFX350 is a mobile computer for commissioning and maintenance. It enables efficient device configuration and diagnostics for HART and FOUNDATION Fieldbus devices in the non-Ex area .  For details, see Operating Instructions BA01202S |
| Field Xpert SFX370 | Field Xpert SFX370 is a mobile computer for commissioning and maintenance. It enables efficient device configuration and diagnostics for HART and FOUNDATION Fieldbus devices in the non-Ex area and the Ex area .  For details, see Operating Instructions BA01202S |

Service-specific accessories

| Accessories | Description |
|-------------|--|
| Applicator | Software for selecting and sizing Endress+Hauser measuring devices: <ul style="list-style-type: none"> ▪ Calculation of all the data needed to determine the optimum flowmeter: e.g. nominal diameter, pressure drop, performance characteristics or process connections. ▪ Graphic illustration of the calculation results Administration, documentation and access to all project-related data and parameters throughout the entire life cycle of a project. Applicator is available: <ul style="list-style-type: none"> ▪ Via the Internet: https://wapps.endress.com/applicator ▪ On CD-ROM for local PC installation. |

| | |
|-----------|--|
| W@M | <p>Life cycle management for your plant</p> <p>W@M supports you with a wide range of software applications over the entire process: from planning and procurement, to the installation, commissioning and operation of the measuring devices. All the relevant information is available for every measuring device over time entire life cycle, such as the device status, spare parts, device-specific documentation, etc.</p> <p>The application already contains the data of your Endress+Hauser device. Endress+Hauser also takes care of maintaining and updating the data records.</p> <p>W@M is available:</p> <ul style="list-style-type: none"> ■ Via the Internet: www.endress.com/lifecyclemanagement ■ On CD-ROM for local PC installation. |
| FieldCare | <p>FDT-based plant asset management tool from Endress+Hauser.</p> <p>It can configure all smart field units in your system and helps you manage them. By using the status information, it is also a simple but effective way of checking their status and condition.</p> <p> For details, see Operating Instructions BA00027S and BA00059S</p> |

System components

| Accessories | Description |
|--------------------------------------|---|
| Memograph M graphic display recorder | <p>The Memograph M graphic display recorder provides information on all relevant measured variables. Measured values are recorded correctly, limit values are monitored and measuring points analyzed. The data are stored in the 256 MB internal memory and also on a SD card or USB stick.</p> <p> For details, see "Technical Information" TI00133R and Operating Instructions BA00247R</p> |
| RN221N | <p>Active barrier with power supply for safe separation of 4-20 mA standard signal circuits. Offers bidirectional HART transmission.</p> <p> For details, see "Technical Information" TI00073R and Operating Instructions BA00202R</p> |
| RNS221 | <p>Supply unit for powering two 2-wire measuring devices solely in the non-Ex area. Bidirectional communication is possible via the HART communication jacks.</p> <p> For details, see "Technical Information" TI00081R and Brief Operating Instructions KA00110R</p> |

Documentation

-  For an overview of the scope of the associated Technical Documentation, refer to the following:
- The CD-ROM provided for the device (depending on the device version, the CD-ROM might not be part of the delivery!)
 - The *W@M Device Viewer* : Enter the serial number from the nameplate (www.endress.com/deviceviewer)
 - The *Endress+Hauser Operations App*: Enter the serial number from the nameplate or scan the 2-D matrix code (QR code) on the nameplate.

Standard documentation

Brief Operating Instructions

| Measuring device | Documentation code |
|------------------|--------------------|
| Promag P 200 | KA01121D |

Operating Instructions

| Measuring device | Documentation code | | |
|------------------|--------------------|---------------------|-------------|
| | HART | FOUNDATION Fieldbus | PROFIBUS PA |
| Promag P 200 | BA01111D | BA01378D | BA01376D |

Device Parameters

| Measuring device | Documentation code | | |
|------------------|--------------------|---------------------|-------------|
| | HART | FOUNDATION Fieldbus | PROFIBUS PA |
| Promag 200 | GP01026D | GP01028D | GP01027D |

Supplementary device-dependent documentation

Safety Instructions

| Contents | Documentation code |
|----------------------------|--------------------|
| ATEX/IECEX Ex d[ia], Ex tb | XA01015D |
| ATEX/IECEX Ex ia, Ex tb | XA01016D |
| ATEX/IECEX Ex nA, Ex ic | XA01017D |
| cCSAus XP (Ex d) | XA01018D |
| cCSAus IS (Ex i) | XA01019D |
| NEPSI Ex d | XA01179D |
| NEPSI Ex i | XA01178D |
| NEPSI Ex nA, Ex ic | XA01180D |
| INMETRO Ex d | XA01309D |
| INMETRO Ex i | XA01310D |
| INMETRO Ex nA | XA01311D |

Special Documentation

| Contents | Documentation code |
|---|--------------------|
| Information on the Pressure Equipment Directive | SD01056D |
| Functional Safety Manual | SD01451D |
| Heartbeat Technology | SD01452D |

Installation Instructions

| Contents | Documentation code |
|---|---|
| Installation Instructions for spare part sets | Specified for each individual accessory |

Registered trademarks

HART®

Registered trademark of the HART Communication Foundation, Austin, USA

PROFIBUS®

Registered trademark of the PROFIBUS User Organization, Karlsruhe, Germany

FOUNDATION™ Fieldbus

Registration-pending trademark of the Fieldbus Foundation, Austin, Texas, USA

Applicator®, FieldCare®, Field Xpert™, HistoROM®, Heartbeat Technology™

Registered or registration-pending trademarks of the Endress+Hauser Group

www.addresses.endress.com
